

Pedestrian Safety and Accessibility Best Practices for Channelized Right-Turn Lanes

Timothy J. Gates, Principal Investigator

Department of Civil and Environmental Engineering

Michigan State University

December 2024

Research Project

Final Report 2024-31

To get this document in an alternative format or language, please call 651-366-4720 (711 or 1-800-627-3529 for MN Relay). You can also email your request to ADArequest.dot@state.mn.us. Please make your request at least two weeks before you need the document.

Technical Report Documentation Page

1. Report No. MN 2024-31	2.	3. Recipients Accession No.	
4. Title and Subtitle Pedestrian Safety and Accessibility Best Practices for Channelized Right-Turn Lanes		5. Report Date December 2024	
		6.	
7. Author(s) Timothy J. Gates, Jonathan J. Kay, and Peter T. Savolainen		8. Performing Organization Report No.	
9. Performing Organization Name and Address Department of Civil and Environmental Engineering Michigan State University East Lansing, MI 48824		10. Project/Task/Work Unit No.	
		11. Contract (C) or Grant (G) No. (c) 1036336 (wo) 10	
12. Sponsoring Organization Name and Address Minnesota Department of Transportation Office of Research & Innovation 395 John Ireland Boulevard, MS 330 St. Paul, Minnesota 55155-1899		13. Type of Report and Period Covered Final Report	
		14. Sponsoring Agency Code	
15. Supplementary Notes http://mdl.mndot.gov/			
16. Abstract (Limit: 250 words) This research sought to identify best practices for channelized right-turn lanes (CRT) that better accommodate the safety and accessibility needs of all road users. This was accomplished through a comprehensive literature review, a state-of-the-practice survey of state and local roadway agencies (nationwide and within Minnesota), a review of agency policy and guidance materials (nationwide and MnDOT), and a series of focus group meetings focused on vulnerable road users. Feedback received both from the survey of transportation agencies and the focus group sessions performed as a part of this research suggest that roadway agencies throughout the United States are moving toward proactive policies for the use of CRTs that emphasize safety and mobility for vulnerable road users. This movement is generally based on the concerns for the safety of vulnerable road users outlined in the prior section and commonly includes 1.) minimizing the use of CRTs at urban and suburban intersections and/or 2.) designing new CRT facilities or retrofitting existing facilities with mitigation strategies to improve the safety and accessibility for vulnerable road users. This information was synthesized along with the best practices found in the research literature and agency policy/guidance materials to develop implementation guidance, which is organized within the report as follows: 1.) guidance for use of CRTs based on the project scenario; 2.) traffic control recommendations for CRTs; 3.) recommended design features for CRTs; and 4.) recommended mitigation strategies intended to improve CRT safety and/or accessibility for vulnerable road users.			
17. Document Analysis/Descriptors Channelized intersections, Right turns, Pedestrian safety, Bicycles, Vulnerable road users, Accessibility		18. Availability Statement No restrictions. Document available from: National Technical Information Services, Alexandria, Virginia 22312	
19. Security Class (this report) Unclassified	20. Security Class (this page) Unclassified	21. No. of Pages 124	22. Price

Pedestrian Safety and Accessibility Best Practices for Channelized Right-Turn Lanes

Final Report

Prepared by:

Timothy J. Gates, Ph.D., P.E.

Jonathan J. Kay, Ph.D., P.E.

Peter T. Savolainen, Ph.D., P.E., F.ITE

Department of Civil and Environmental Engineering

Michigan State University

December 2024

Published by:

Minnesota Department of Transportation

Office of Research & Innovation

395 John Ireland Boulevard, MS 330

St. Paul, Minnesota 55155-1899

This report represents the results of research conducted by the authors and does not necessarily represent the views or policies of the Minnesota Department of Transportation or Michigan State University. This report does not contain a standard or specified technique.

The authors, the Minnesota Department of Transportation, and [author's organization] do not endorse products or manufacturers. Trade or manufacturers' names appear herein solely because they are considered essential to this report.

Acknowledgements

The research team would like to acknowledge the Minnesota Department of Transportation (MnDOT) for sponsoring this research. The efforts of the Technical Advisory Panel (Reuben Collins, Amber Dallman, Nick Erpelding, Mitchell Kiecker, Victor Lund, Tim Plath, Ted Schoenecker, Scott Thompson, Susan Zarling) were also very helpful over the course of the project, including assistance with organizing the focus groups and reviewing the project deliverables. The team would also like to specifically acknowledge the efforts of Project Coordinator Briah Carlson and Technical Liaison Joe Gustafson.

Table of Contents

Chapter 1: Introduction	1
1.1 Research Objectives and Methods	2
Chapter 2: Literature Review	4
2.1 General Planning and Design Considerations.....	4
2.1.1 Pedestrian Considerations	5
2.1.2 On-Road Bicyclist Considerations.....	7
2.1.3 Types of Traffic Control for Vehicular Movements	7
2.1.4 Geometric Design Considerations.....	8
2.1.5 Safety Performance.....	9
2.2 Design Features and Mitigation Strategies.....	11
2.2.1 Crosswalk Surface Treatments	11
2.2.2 Crosswalk Placement	14
2.2.3 Traffic Control Devices	16
2.2.4 Geometric Design Strategies.....	20
Chapter 3: Current Practice in the United States	24
3.1 Survey of State and Local Agencies	24
3.1.1 Agency Use of CRTs	25
3.1.2 Traffic Control Type.....	26
3.1.3 Crosswalk Surface Treatments.....	27
3.1.4 Crosswalk Placement	28
3.1.5 Crosswalk Signing and Beacon Treatments.....	29
3.1.6 Traffic Signal Strategies	30
3.1.7 Geometric Design Strategies.....	31
3.1.8 Other Comments from State and Local Agencies	32

3.1.9 Examples of Innovative CRT Designs	33
3.2 Summary of State DOT Policy and Guidance Related to CRTs	37
Chapter 4: Current Practice in Minnesota	43
4.1 MnDOT’s Current Guidance Related to CRTs	43
4.2 Minnesota Local Roadway Agency Focus Group and Survey	44
4.2.1 Perspectives and Current Practices of Minnesota Local Agencies.....	45
4.2.2 CRT Design Features and Mitigation Strategies	46
Chapter 5: Vulnerable Road User Focus Groups	52
5.1 Current Agency Practices.....	52
5.2 General Pedestrian Considerations	53
5.3 Considerations for Pedestrians with Vision Impairments	54
5.3.1 Orientation and Wayfinding.....	54
5.3.2 Interactions with Drivers.....	55
5.4 Considerations for On-Road Bicyclists.....	56
5.5 Traffic Control Considerations.....	56
5.6 Crosswalk Surface Treatments	57
5.6.1 High-Visibility Crosswalk Markings.....	57
5.6.2 Advance Yield Markings	57
5.6.3 Textured Crosswalks.....	57
5.6.4 Raised Crossings	58
5.7 Crosswalk Placement.....	59
5.8 Crosswalk Signs and Beacon Treatments	60
5.8.1 Signs	60
5.8.2 Beacons	61
5.9 Traffic Signal Treatments.....	61

5.9.1 Right Turn on Red Prohibitions	61
5.9.2 Accessible Pedestrian Signals	62
5.10 Geometric Design Strategies	62
5.10.1 Deceleration and Acceleration Lanes.....	62
5.10.2 Modern Low Angle of Entry Designs	62
5.10.3 Lane Narrowing and Radius Reductions.....	63
5.10.4 Truck Aprons	63
5.10.5 Ramped vs. Cut-Through Channelizing Island Designs	64
Chapter 6: Conclusions and Recommendations	66
6.1 Benefits and Drawbacks of CRTs	66
6.2 Recommendations for CRT Design and Implementation	67
6.2.1 Recommended CRT Use by Project Scenario	68
6.2.2 Recommended Traffic Control for CRTs.....	70
6.2.3 Recommended CRT Design Features	72
6.2.4 Mitigation Strategies for CRTs.....	75
References.....	79
Appendix A: Roadway Agency Survey Questionnaire Form	
Appendix B. Minnesota Local Agency Participants	
Appendix C. Vulnerable Road User Focus Group Participants	

List of Figures

Figure 1. Example a signalized intersection with channelized right turns (CRTs) in Austin, Texas [3].	1
Figure 2. Process to identify best practices and develop recommended guidance for CRTs in Minnesota.	2
Figure 3. Advantages and disadvantages of CRTs for pedestrians (Table 5-1 - NCHRP Research Report 834) [25].	6
Figure 4. Examples of four common types of vehicular traffic control at CRTs [3].	8
Figure 5. Conventional high angle (Left) vs. modern low angle (right) of entry island design at CRTs [25].	10
Figure 6. Crosswalk pavement markings (Figure 3C-1 from the MUTCD) [28].	12
Figure 7. Example of high-visibility crosswalk pavement markings at CRTs [3].	12
Figure 8. Example of advance yield markings at CRTs [3].	13
Figure 9. Examples of textured crosswalks at CRTs [3].	13
Figure 10. Example of raised crossing at a CRT [3].	14
Figure 11. Examples of crosswalk placement options for CRTs [1].	15
Figure 12. Examples of center-perpendicular crosswalk placement at CRTs [3].	16
Figure 13. MUTCD pedestrian crossing signs commonly used at CRTs [28].	17
Figure 14. Examples of RRFBs and PHBs used at CRTs or roundabouts [3, 33].	18
Figure 15. Example of on-pavement sound strips at CRTs [25].	20
Figure 16. Example of cut through and ramped approaches to island design at CRT [3].	21
Figure 17. Example of modern low angle of entry CRT design [33].	22
Figure 18. Example of conventional high angle vs. modern low angle of entry island design at CRT [3].	22
Figure 19. Examples of deceleration and acceleration lanes at CRTs [3].	23
Figure 20. Map of responding state and local agencies.	25
Figure 21. Lamar Boulevard at W 29th Street in Austin, Texas [3].	33
Figure 22. CO-470 Exit Ramp to W Ken Caryl Avenue in Littleton, Colorado [3].	34
Figure 23. Arapahoe Street and Speer Boulevard in Denver, Colorado [3].	34

Figure 24. I-20 Exit Ramp at Main Street in Elk City, Oklahoma [3].....	35
Figure 25. OR-18 at Pacific Highway in Dundee, Oregon [3].	35
Figure 26. Edgewater Street Entrance Ramp to OR-22 in Salem, Oregon [3].	36
Figure 27. US-20 at Butler Market Road in Bend, Oregon [3].	36
Figure 28. I-5 Exit Ramp at Mill Plain Boulevard in Vancouver, Washington [3].....	37
Figure 29. Fremont Avenue at 34th Street in Seattle, Washington [3].	37
Figure 30. Map of participating local roadway agencies in Minnesota.	45
Figure 31. Example of lane narrowing/radius reduction with truck apron.	51
Figure 32. Example of tactical walking surface indicators at a roundabout.....	55
Figure 33. North 7th Street in Harrisburg, Pennsylvania [3].....	59
Figure 34. Veirs Mill Road and Connecticut Avenue in Silver Spring, Maryland [3].	60
Figure 35. Peace Portal Drive and Hughes Avenue in Blaine, Washington [3].	64
Figure 36. Washington Route 520 and NE 51st Street in Redmond, Washington [3].	64
Figure 37. NE 171st Street and 135th Avenue in Woodinville, Washington [3].....	64

List of Tables

Table 1. Summary of Key National References for CRT Planning and Design	5
Table 2. Summary of CRT Geometric Design Elements Impact on Pedestrian and Bicyclists	9
Table 3. Use of CRTs at Signalized Intersections where Pedestrians are Expected to Cross (N = 49)	25
Table 4. Type of Traffic Control Used within the CRT Lane by Agency Type	26
Table 5. Crosswalk Surface Treatments for CRTs by Agency Type	27
Table 6. Crosswalk Placement at CRTs by Agency Type	28
Table 7. Crosswalk Signs and Beacons Used at CRTs by Agency Type.....	29
Table 8. Traffic Signal Strategies for CRTs by Agency Type.....	30
Table 9. Geometric Design Strategies for CRTs by Agency Type	31
Table 10. Summary of Other Comments from State and Local Agencies.....	32

Table 11. Summary of State DOT Policies and Guidance for CRTs	38
Table 12. Summary of MnDOT’s Current Guidance Related to CRTs	43
Table 13. Type of Traffic Control Used by Minnesota Local Agencies at CRTs (N = 8)	47
Table 14. Minnesota Local Agency Crosswalk Surface Treatments for CRTs (N = 8).....	47
Table 15. Minnesota Local Agency Crosswalk Placement at CRTs (N = 8).....	48
Table 16. Minnesota Local Agency Crosswalk Signs and Beacons Used at CRTs (N = 8)	48
Table 17. Minnesota Local Agency Traffic Signal Strategies for CRTs (N = 8).....	49
Table 18. Minnesota Local Agency Geometric Design Strategies for CRTs (N = 8).....	50
Table 19. Recommended CRT Use by Project Scenario	69
Table 20. Recommended Traffic Control for CRTs.....	70
Table 21. Recommended CRT Design Features	72
Table 22. Mitigation Strategies for CRTs.....	76

Executive Summary

This research, *Pedestrian Safety and Accessibility Best Practices for Channelized Right-Turn (CRT) Lanes* (NS-694), sought to identify best practices for right-turn channelization that better accommodate the safety and accessibility needs for all road users. This was accomplished through a comprehensive literature review, a state-of-the-practice survey of state and local roadway agencies (nationwide and within Minnesota), a review of agency policy and guidance materials (nationwide and MnDOT), and a series of focus group meetings focused on vulnerable road users. The findings obtained from these tasks, which are presented in detail in **Chapters 2 – 5** of this report, were used to develop a series of conclusions and recommendations related to the design and implementation of CRTs within Minnesota to mitigate potential safety and accessibility concerns for vulnerable road users, particularly people with vision impairments or other disabilities. A summary of the current nationwide state of the practice regarding the use of CRTs is provided in the following section. Thereafter, a summary of the conclusions and recommendations related to the design and implementation of CRTs within Minnesota are provided.

State of the Practice for CRT use in the United States

A topical summary of the current nationwide state of the practice regarding the use of CRTs in urban and suburban contexts is provided here. This summary begins with a general overview on the use of CRTs at signalized intersections in urban and suburban areas, before shifting focus to the use of design elements that can influence safety and mobility for vulnerable road users, particularly those with vision impairments or other disabilities.

Use of CRTs in Urban and Suburban Contexts

While the American Association of State Highway and Transportation Officials (AASHTO) *Green Book* recognizes that CRTs can enhance both operational and safety performance when used in appropriate settings [2], these designs can also present potential safety and accessibility issues for bicyclists and pedestrians, particularly those with vision impairments or other disabilities. Prior work has established a number of primary reasons for employing a CRT design from a general perspective [1, 2], largely including operational benefits that increase capacity at intersections. These designs can also offer potential safety benefits for both motorized and non-motorized road users by separating conflict points or accommodating awkward geometric conditions.

Given these potential advantages, CRTs therefore represent a potential tool that designers may wish to consider as a part of managing the road network in a manner that maximizes safety and mobility for all road users. However, CRTs also represent a unique challenge to pedestrians (particularly those with vision disabilities) due to the fact many of these crossings are often unsignalized and vehicle trajectories are often curved [14] in an environment where turning speeds can reach up to 30 miles per hour depending on the geometric design [14]. This is further complicated by the fact that drivers may be looking for gaps

in vehicular traffic along the intersecting roadway, which may reduce their ability to notice pedestrians approaching from the other direction [14].

Although several prior studies have evaluated the safety performance of CRTs and related design elements [15-21], there remains a need for more information as to the safety performance effects of these facilities. This is particularly true with respect to safety performance for pedestrians and bicyclists as well as the myriad of jurisdiction-specific design strategies employed by roadway agencies. Given the range of traffic control and geometric characteristics associated with CRTs, quantifying the effects of these designs on pedestrian and bicycle safety performance would require considerable research that is beyond the scope of this project. Additional details related to the literature on CRT safety performance is provided within the report.

There is an important difference between safety performance for pedestrians and accessibility [25]. Both roadway agencies and participants in the vulnerable road user focus group sessions identified a number of ways that CRTs can result in a difficult and uncomfortable crossing environment for pedestrians. Roadway agencies discussed the fact that CRTs often include corner radii or excessively wide pavement cross-sections that allow for higher turning speeds relative to typical right turns. Roadway agencies also recognized that the use of CRTs could result in longer overall crossing distances as well as out-of-direction travel for pedestrians depending on the specific design.

Participants in the focus group sessions consistently noted that the atypical crossing experience at CRTs represents a major barrier for pedestrians with vision disabilities. These facilities can represent a challenging task for visually impaired pedestrians from a wayfinding perspective, particularly with respect to identifying the appropriate location to cross. Strategies that are employed by people with disabilities to cross at conventional intersections may not work at CRTs, and techniques to cross these facilities may be outside of common training provided to these road users. A common theme among stakeholders was that pedestrians with vision disabilities will avoid crossing these facilities if possible.

The combination of on-road bicycle facilities with CRTs presents a traffic control issue specific to bicyclists [1]. Roadway agencies and other safety stakeholders identified on-road bicyclists being overtaken within the channel and conflicts at the point of entry as scenarios in which there have been problematic interactions with drivers. It is also important to consider connectivity and safety for bicyclists traveling outside of the roadway, particularly in scenarios where shared-use paths or adjacent trails cross the facility. One innovative approach that was identified by roadway agencies was connecting bicycle lanes with sidepaths upstream of intersections to allow bicyclists who feel uncomfortable traveling within the roadway at these locations to move to bicycle-specific facilities outside of the traveled way. While there is a lack of published work in this area, roadway agencies have employed a number of designs to accommodate both on-road and off-road bicyclists at signalized intersections with CRTs, details of which are provided in the report.

Consistent with the national adoption of the *Safe System Approach* [7], roadway agencies are moving toward proactive policies for the use of CRTs that emphasize safety and mobility for vulnerable road users. This movement is generally based on the concerns outlined above and commonly includes either

minimizing the use of CRTs in urbanized areas or retrofitting existing facilities with mitigation strategies to improve the crossing experience. Local roadway agencies located within major metropolitan areas have placed a particular emphasis on removing CRTs to improve conditions for pedestrians and bicyclists. It is also important to recognize that agencies are currently working to modify design guidance to reflect the revised U.S. Access Board’s *Public Right-of-Way Accessibility Guidelines* (PROWAG) requirements [48] for multilane channelized right-turn lanes. Orientation and mobility specialists also noted that tactile walking surface indicators positioned on the sidewalk near the landing area may represent a potential option to enhance wayfinding for visually impaired pedestrians.

Traffic Control at CRTs

The specific type of traffic control used on the CRT represents the component that most directly affects the crossing experience for pedestrians and bicyclists at CRTs [1], although there is limited research to quantify the safety performance associated with the common types of traffic control used at CRT lanes. Roadway agencies typically do not maintain specific policies to determine the type of traffic control used at CRTs, where this decision is often left to the designer and typically is based on traffic volumes, site characteristics, or other agency-specific policies. This contributes to a lack of consistency in design, even within a single jurisdiction. This lack of consistency was consistently cited by safety stakeholders as one of the common concerns for pedestrians with vision disabilities related to CRTs. A summary of findings specific to each of the four traffic control strategies is presented in **Table i**.

Table i. Summary of Findings Related to Traffic Control at CRTs

Type of Traffic Control	Finding
Uncontrolled	While uncontrolled CRTs remain in place throughout the United States, roadway agencies are placing a specific emphasis on reducing the use of these “free-right-turn” designs at locations where pedestrians are expected to cross. Stakeholders identified these uncontrolled designs as particularly uncomfortable for pedestrians with vision disabilities, consistent with the findings of prior work.
Yield Control	Yield control represents the predominant traffic control for CRTs at signalized intersections in urbanized areas across the United States. While this often includes a yield sign placed at the downstream exit of the channelized lane, it should be noted that roadway agencies have employed a range of configurations where the R1-2 sign is placed further upstream. Roadway agencies will also sometimes include advance yield line pavement markings consistent with the MUTCD. Roadway agencies identified the potential confusion caused by the intent of yield signs at CRTs as these signs are intended to control the vehicular conflict and are not intended to control the crosswalk upstream of the intersecting street. This concept is particularly important for states that maintain laws that require drivers to stop for pedestrians who are within the crosswalk (as opposed to yield). Participants in the focus group sessions also noted yield control can result in pedestrians feeling vulnerable while completing the crossing movement.
Stop Control	Stop control represents a less commonly used option for traffic control at CRTs in the United States. While stop control may offer benefits to pedestrians and bicyclists at specific locations by enforcing a regulatory complete stop within the channel, this concept also works to negate the operational benefits gained from the reduction in unnecessary stops at CRTs. As a result, there is relatively scarce guidance available specific to the use of stop control at CRTs. Stop

Type of Traffic Control	Finding
	control may represent a low-cost temporary option to improve the crossing environment for pedestrians at locations with no control or yield control in scenarios where turning volumes are relatively low. Similar to the case with yield signs, confusion may be caused by the intent of the stop signs at CRTs as these signs are intended to control the vehicular conflict and are not intended to control the crosswalk upstream of the intersecting street.
Signal Control	Roadway agencies commonly control channelized lanes with signalization in urbanized areas, particularly at locations with relatively high right-turn volumes that require dual CRTs. There is a general perception among roadway agencies and other safety stakeholders that traffic signal control provides the safest and most comfortable crossing experience. It is also worth noting that at least one agency has moved towards the use of signal control for all new CRTs to meet state access board requirements. Signal control is also identified as one of the treatments included within the revised PROWAG requirements [48] for multilane channelized facilities.

Crosswalk Surface Treatments for CRTs

Roadway agencies have deployed a number of surface treatments at crossings to enhance safety and mobility for pedestrians and bicyclists at these facilities. This has typically included high-visibility crosswalk markings, advance yield markings, textured crosswalks, and raised crossings. A summary of findings specific to these treatments is provided in **Table ii**.

Table ii. Summary of Findings Related to Crosswalk Surface Treatments

Strategy	Finding
High-Visibility Crosswalk Markings	<p>High-visibility crosswalk markings are a common means to enhance the visibility of pedestrian crossings. These treatments include longitudinal bars, ladder, or bar pair markings as opposed to conventional transverse markings [28]. Prior work has demonstrated that high-visibility crosswalk markings were associated with an increase in drivers yielding to pedestrians compared to conventional transverse markings in other environments [31].</p> <p>Given these advantages, high-visibility crosswalk markings represent a common treatment employed by roadway agencies to provide additional conspicuity for crossings at CRTs beyond conventional transverse markings. Several roadway agencies have identified high-visibility crosswalk markings as the standard treatment for CRT designs and other safety stakeholders supported using these pavement markings to enhance crossings.</p>
Advance Yield Markings	Roadway agencies have regularly used advance yield line markings at CRTs depending on site conditions. Prior research has demonstrated that the use of advance yield or stop markings and related signs at uncontrolled pedestrian crossings reduced vehicle-pedestrian collisions by 25 percent in a general setting [32].
Textured Crosswalks	Textured crosswalks, which are formed using a texturized pattern that is typically imprinted into the crosswalk surface, have been used as a crosswalk enhancement by roadway agencies at CRTs in urbanized areas across the country. However, a number of agencies indicated that they currently do not permit the use of textured crosswalk surfaces. This is due to a combination of both maintenance concerns and a lack of important retroreflective materials. Orientation and mobility specialists indicated that pedestrians with vision impairments may have trouble recognizing the textured crosswalk if a cane is not constantly in contact with the surface.
Raised Crossings	While raised crossings have not yet become a common treatment specific to CRTs, this strategy is receiving new attention from roadway agencies across the United States for this context. This is particularly true in light of the revised PROWAG requirements [48] that identify raised crossings as a potential treatment to satisfy accessibility requirements for multilane facilities. Prior work

Strategy	Finding
	<p>[13, 33] has suggested the use of raised crosswalks for CRTs as a traffic calming treatment that may provide a continuous accessible travel path for pedestrians and bicyclists. At least one local agency has moved to include the use of raised crossings as a standard for CRT design.</p> <p>Roadway agencies did identify difficulties related to winter maintenance or buses bottoming out after passing over the facility due to the total height of the raised crossing. However, other roadway agencies emphasized during the focus group sessions that the grade break and ramp design can help to ensure the treatment is effective, even in cases where the total height of the raised crossing is relatively low.</p> <p>It is also critical to ensure that these designs consider how pedestrians with disabilities will interact with the crossing. For example, designs without any slope before the crosswalk or misaligned detectable warning devices can lead to potential confusion. On the other hand, orientation and mobility specialists indicated that there could be wayfinding advantages related to the sloped edges of raised crosswalks keeping pedestrians with vision disabilities on the intended path.</p> <p>Ultimately, raised crossings have been used effectively to enhance crossings in other contexts [62] and represent a promising mitigation strategy for CRTs if maintenance and design concerns can be addressed. However, it must be noted that raised crossings are typically not utilized on State Aid routes in Minnesota.</p>

Crosswalk Placement within CRTs

Beyond the details provided in the Manual on Uniform Traffic Control Devices (MUTCD) that apply to markings for crosswalks [28], roadway agencies have implemented a range of crosswalk placement designs within CRTs. Consistent with prior work, center-perpendicular placement remains the most common approach employed by both state and local roadway agencies. Other placement strategies are used depending on site-specific conditions or agency-specific guidance. While more detail related to crosswalk placement can be found in the report, key design principles to encourage a safe and accessible crossing include:

- The overall crossing distance should be minimized to minimize exposure.
- Out-of-direction travel should also be minimized to the extent possible.
- Pedestrians need sight lines toward approaching vehicles to identify safe gaps, and drivers need visibility of the crosswalk to identify pedestrians.
- Drivers also require visibility of traffic control devices specific to the crosswalk (such as warning signs or hybrid beacons).
- Positive wayfinding guidance should be included with all designs and crosswalks that meet the channelizing island approximately in the center can help to minimize concerns related to pedestrians with vision disabilities missing the island.
- Ensure that curb ramps and all other Americans with Disabilities Act (ADA) features are aligned with the intended crossing path.
- Designs should attempt to separate decision points for drivers between interacting with crossing facilities and identifying gaps in cross street traffic.

Crosswalk Signs and Beacon Treatments for CRTs

Roadway agencies have also employed a range of crosswalk signs and beacon treatments to enhance crossings at CRTs beyond the typical traffic control devices incorporated within these designs. While these treatments can help to enhance crossings at CRTs, a fundamental principle identified by agencies was to ensure that the use of these devices does not result in a cluttered environment that occludes pedestrians waiting to complete crossing movements or other traffic control devices at the facility. A summary of findings specific to crosswalk signs and beacon treatments is provided in **Table iii**.

Table iii. Summary of Findings Related to Crosswalk Signs and Beacon Treatments

Strategy	Finding
W11-2 <i>Pedestrian Crossing Warning Signs</i>	W11-2 signs represent the most common crosswalk signing enhancement for CRTs used by state and local roadway agencies in the United States. These signs were also generally supported by participants in the vulnerable road user focus groups. It should be noted that several roadway agencies discussed using these devices on a case-by-case basis as there may be site-specific situations where visual clutter represents a potential concern.
R1-5 <i>Yield or Stop Here for Pedestrian Signs</i>	Roadway agencies have employed R1-5 signs in either the stop or yield variant (consistent with applicable state law) to enhance crossings at CRTs with a variety of design configurations. While this has historically included single lane channelized facilities across the United States, it is important to note that the 11 th edition of the MUTCD may limit the use of R1-5 signs to multilane applications [28].
R1-6 <i>In-Street Pedestrian Crossing Signs</i>	While several roadway agencies responded that R1-6 signs have been used to enhance crossings at CRTs, no examples of their use at CRTs were provided to the research team. It should also be noted that the 11 th edition of the MUTCD may limit the applicability of these signs based on placement criteria [28].
R10-15 <i>Turning Vehicles Yield to/Stop for Pedestrians Signs</i>	Several agencies also identified the use of R10-15 signs in either the stop or yield variant (consistent with state law) to emphasize crossings at CRTs with a variety of configurations. These signs may offer an alternative to R1-5s for single lane channelized facilities given the multilane restriction included in the 11 th edition of the MUTCD [28].
Pedestrian-Actuated Beacons or Warning Devices	<p>Roadway agencies have also used a range of pedestrian-actuated beacons or warning devices to improve the safety performance of unsignalized crossing locations, including conventional flashing amber beacons, rectangular rapid-flashing beacons (RRFBs), and pedestrian hybrid beacons (PHBs)</p> <p>RRFBs are pedestrian-actuated conspicuity enhancements that are used in conjunction with other devices to improve the safety performance of uncontrolled crossings [43]. PHBs are a special type of hybrid beacon that consists of two red lenses above a single yellow lens intended to both warn and control traffic at unsignalized marked crosswalks [28, 43]. Both devices have been associated with pedestrian crash reductions and increases in yielding compliance in a variety of roadway environments [32, 40, 44-47]. Both RRFBs and PHBs are included within revised PROWAG requirements [48] as potential treatments to satisfy accessibility requirements for multilane facilities.</p> <p>RRFBs have become the most common pedestrian beacon treatment at CRTs across the country. It should be noted that a primary drawback identified among stakeholders was the lack of a regulatory stop indication provided by the treatment when compared to either a PHB or a conventional traffic signal. While the use of PHBs at CRTs is much less common than RRFBs, agencies did note that they are currently exploring the use of these devices. Ultimately, the use of RRFBs or PHBs are site-specific treatments that can be considered on a case-by-case basis to enhance crossings at CRTs.</p>

Signalization Strategies for CRTs

While traffic signal design and operational analysis for CRTs is beyond the scope of this effort, several general signalization strategies were identified that can offer the potential to improve safety and accessibility for vulnerable road users. These findings are summarized in **Table iv**. In addition, more detail related to operational analysis for CRTs can be found in NCHRP Web-Only Document 208: *Design Guidance for Channelized Right-Turn Lanes* (2014) [15].

Table iv. Summary of Findings Related to Signalization Strategies

Strategy	Finding
APS Devices	In general, appropriate APS devices are implemented at CRTs controlled by a signal consistent with state law, agency policy, and Access Board requirements. The placement of these devices at CRTs requires careful consideration due to the atypical nature of these designs. This has represented a design challenge at some locations related to space limitations due to the need for additional poles to support equipment within the channelizing island as well as at corner of the approach. Orientation and mobility specialists noted that there has been exploratory research to determine the most effective use of audible countdowns included with APS devices as there may be potential drawbacks when devices are located close together or if the countdown message makes it more difficult for pedestrians with vision impairments to hear yielding vehicles. Orientation and mobility specialists also emphasized the need for APS devices when RRFBs or PHBs are used to ensure that these treatments are helpful for pedestrians with visual disabilities.
Signal Phasing Strategies	There is only limited guidance available for phasing strategies specific to CRTs controlled by a traffic signal. Ultimately, signal timing and phasing often is left to the discretion of the designer based on site and traffic characteristics. It is general practice to phase the pedestrian crossing at the CRT lane to run opposite of the phases for the conflicting right-turning traffic at the CRT, including through-traffic phases and any overlapped right-turn phases. Modern signal controllers often allow for pedestrian phases to be overlapped, which provides the potential for more efficient pedestrian signal timing and reduced crossing times. The use of pedestrian-focused phasing strategies (such as leading pedestrian intervals or exclusive pedestrian phases) may have a role in accommodating pedestrians at CRTs but there is only limited information to provide guidance related to these strategies.
Right Turn on Red Restrictions	Both static and dynamic Right Turn on Red (RTOR) restrictions have been used by roadway agencies to improve safety and accessibility for pedestrians at CRTs. Intuitively, static RTOR restrictions implemented via conventional signs appear to be more common than dynamic RTOR restrictions implemented via “blank-out” signs that provide an illuminated message to drivers that communicates the dynamic restriction. Again, there is limited information to provide guidance specific to RTOR restrictions for CRTs beyond the concept that this represents an alternative for designs to consider.
Traffic Signal Indications	State and local roadway agencies have used a broad range of traffic signal head configurations at CRTs, from conventional green ball indications to the use of flashing yellow arrows. Flashing yellow arrows tended to be the least commonly used option and the use of green ball and green arrow indications were nearly identical among state DOTs. There is limited information with respect to the most effective traffic signal indications for CRTs and most commonly this decision is determined by agency policy and preference.
Traffic Signal Placement Strategies	Both roadside or overhead signal head placements (or a combination of roadside and overhead signals) have been used by roadway agencies at CRTs. Overhead signal placements tended to be most commonly used approach among state DOTs. There is limited information with respect to the most effective traffic signal placement for CRTs and most commonly this decision is determined by site-specific characteristics or agency preference.

Geometric Design Strategies for CRTs

The fundamental geometric design elements of CRTs have a major influence on the safety and accessibility for non-motorized road users. Roadway agencies have therefore developed strategies related to these geometric design elements to maximize safety, and comfort for all road users. **Table v** provides a summary of findings specific to geometric design strategies for CRTs.

Table v. Summary of Findings Related Geometric Design Strategies

Strategy	Finding
Deceleration and Acceleration Lanes	<p>The inclusion of either deceleration or acceleration lanes represents another important design control for CRTs that have the potential to influence driver behavior. Deceleration lanes have generally been identified as positive for pedestrians given the potential to reduce vehicle speeds as well as the potential for queues at the entrance to the channelized lane [25]. Schroeder et al [25] also suggested that the presence of a deceleration lane may improve the ability for pedestrians with vision disabilities to detect approaching vehicles. Consistent with prior work, deceleration lanes remain a commonly included design element at CRTs across the United States. Stakeholders generally expressed support for the use of deceleration lanes during the user focus group sessions.</p> <p>Schroeder et al [25] suggested that the use of acceleration lanes should be avoided since they are intended to increase speeds. This was also consistent with mobility specialists interviewed by Potts et al [15] that indicated that channelized islands with acceleration lanes were difficult to cross. While acceleration lanes are still commonly in place at CRTs across the United States in a variety of design configurations, roadway agencies have recognized these concerns and are attempting to minimize their use in urbanized areas. Stakeholders expressed a preference for acceleration lanes not being included with CRT designs during the focus group sessions. Consistent with the AASHTO <i>Green Book</i> [2], the use of acceleration lanes should be generally limited to facilities where pedestrians are not expected to cross.</p>
Island Design	<p>Both the AASHTO <i>Green Book</i> [2] and Schroeder et al [25] provide detailed guidance with regard to island design, including appropriate size, crossing path through the island, and other geometric design principles. It is critical to provide appropriate guidance through the channelizing island for pedestrians with vision disabilities and ensure that the area outside of the crossing path be identifiable as a non-walking surface as islands without this guidance can be disorienting [25]. The use of larger islands can help to ensure space for the required traffic control devices, pedestrian pathing, and bicycle storage.</p> <p>Crossing paths through channelizing islands are typically either cut through (or level with the street) or ramped [25]. Both approaches are commonly used by state and local roadway agencies across the United States and have received support from stakeholders depending on site conditions and agency preferences. It should be noted that cut through designs have previously presented challenges related to snow removal for roadway agencies in winter climates.</p>
Modern Low Angle of Entry Design	<p>Recently, roadway agencies have evaluated the use of CRT designs with modified geometry intended to improve visibility and reduce speeds [51]. The design with the relatively high angle of entry may be appropriate for situations where either yield or no control is employed and there is not an expectation of pedestrian crossings [15, 25]. However, the modern design with the relatively low angle of entry is preferred with stop or signal control, particularly when pedestrians are expected to cross the channelized facility [15, 25]. The AASHTO <i>Green Book</i> [2] also recognizes that this design may be used with yield control when geometric conditions are appropriate.</p>

Strategy	Finding
	<p>While research has demonstrated [18-20] that the improved visibility and reduced speeds associated with the modern design reduces total and rear end crashes, the effects on pedestrian-involved crashes remains unclear. However, it is worth noting that research conducted by Schattler et al [18] demonstrated that drivers traversing the modified design used fewer exaggerated head turns, executed fewer “roll-and-go” stops, and were less likely to stop past the stop bar. Therefore, this type of geometry presents a promising strategy for improving pedestrian safety.</p> <p>While the conventional high angle of entry design remains in place at existing CRTs across the United States, roadway agencies have moved towards the modern low angle of entry design as the best practice for new or retrofitted CRTs where pedestrians are expected to be present. Fourteen state DOTs specifically identify or discuss the modern low angle of entry geometric design as a preferred alternative for scenarios where pedestrians are expected to cross. Other safety stakeholders also expressed support for the use of the modern low angle of entry design during the focus group sessions.</p> <p>It should be noted that local roadway agencies identified some potential drawbacks of this design based on recent experience. This included the fact that snow removal may be a challenge in scenarios where the cross street is limited in width, resulting in a relatively small radius for snowplows to navigate. There have also been instances of drivers encroaching beyond the end of the channel into the cross street, resulting in angle collisions. Local agencies also noted that edgeline extensions have been used to help address this concern.</p>
<p>Lane Narrowing, Radius Reductions, and Truck Aprons</p>	<p>Strategies such as lane narrowing and radius reductions have been utilized at CRTs, often as retrofits at existing locations, in an attempt to lower speeds at CRTs. Roadway agencies participating in the focus group sessions discussed the fact that CRTs often include corner radii or excessively wide pavement cross-sections that allow for relatively high turning speeds. This has ranged from permanent changes of the curb line to more short-term applications of bollards or cross-hatched pavement markings.</p> <p>Participants of the focus group sessions agreed that curblines modifications were the most pedestrian-friendly method for providing lane narrowing or radius reductions, as such methods position the pedestrian landing area closer to the traffic lane, thereby improving pedestrian visibility to oncoming drivers and decreasing crossing distances. There was also general consensus that the use of pavement markings for lane narrowing or radius reductions, while less expensive, elicit less effective speed reductions compared to curb extensions, bollards, or other physical barriers used to delineate the vehicle path. These methods are also less desirable than curblines modifications, as the pedestrian landing area would remain at the original curblines, presenting additional wayfinding challenges for visually impaired pedestrians. Bollards are generally viewed as an improvement over pavement markings alone, but are frequently struck by vehicles, which limits their effectiveness. Placement of radius reductions on the right side of the CRT lane will generally achieve the maximum speed reduction effect.</p> <p>Mountable truck aprons are often integrated along with radius reductions to better accommodate the turning requirement of large trucks, while still affording the intended speed reductions. However, roadway agencies noted that these treatments can present challenges with respect to pedestrian ramp and crosswalk design, which can result in wayfinding and orientation challenges for pedestrians with vision disabilities, particularly when determining where to safety stand while waiting to cross. Roadway agencies also provided examples of truck apron designs employed in other contexts where special emphasis has been placed on accommodating pedestrians with vision disabilities. Orientation and mobility specialists noted that tactile walking surface indicators may represent a potential treatment to address this concern in the future.</p>

Recommendations for CRT Use in Minnesota

The research findings were then used to develop implementation guidance for use by transportation agencies in Minnesota, which is organized as follows:

- Guidance for use of CRTs based on the project scenario (e.g., new construction projects, reconstruction projects, or safety projects involving existing CRTs)
- Traffic control recommendations for CRTs
- Recommended design features for CRTs
- Recommended mitigation strategies intended to improve CRT safety and/or accessibility for vulnerable road users

Recommended CRT Use by Project Scenario

Table vi provides recommended guidance for the use of CRTs in urban and suburban contexts based on the project scenario, with separate guidance provided for new construction projects, reconstruction projects, or safety projects involving existing CRTs.

Table vi. Recommended CRT Use by Project Scenario

Scenario	Recommendation
New Construction Projects	CRTs should not be used indiscriminately particularly in urban or suburban areas where pedestrians and bicyclists are expected to be present, and should be used only with careful consideration of overall benefits and disadvantages as it relates to that specific location. CRTs may be a viable alternative in scenarios where skew or other site-specific conditions could result in excessively long or awkward crossing geometry with the use of conventional non-channelized right-turn lanes (consistent with MnDOT Facility Design Guide [54]). There may also be other site-specific scenarios where design alternatives that include a CRT provide the best combination of safety and operational performance. Additionally, there may be scenarios where channelization offers signal phasing advantages.
Reconstruction Projects	When the boundaries of a reconstruction project in an urban or suburban area incorporates signalized intersections with existing CRTs, consideration may be given towards removal of the channelized right-turn lane when such removal may improve conditions for pedestrians and bicyclists. In scenarios where the removal of the CRT is not a feasible alternative, a review of the traffic control configuration should be conducted, and the reconstructed facility should incorporate consistent design features that emphasize pedestrians and bicyclists. Site-specific mitigation strategies should also be considered in order to maximize safety, mobility, and accessibility of the crossing.
Safety Projects Involving Existing Channelized Right-Turn Lanes	Both MnDOT and local roadway agencies should proactively seek to improve existing CRTs at signalized intersections in urban or suburban areas where pedestrians and bicyclists are expected to be present. This may include converting an existing channelized right-turn lane to a conventional right-turn lane or retrofitting these facilities with mitigation treatments intended to improve conditions for pedestrians and/or bicyclists. Such projects should be proactively considered on a systemic basis regardless of the occurrence of traffic crashes or conflicts involving pedestrians or bicyclists, although such data, if available, may also be utilized for support. Particular emphasis should be placed on existing CRTs along school routes or other pedestrian-focused corridors as these facilities can represent a barrier. To support funding for implementation of such projects, this component should be integrated within the Minnesota Highway Safety Improvement Program (HSIP) and equivalent local agency safety program along with other eligible funding programs.

Recommended Traffic Control for CRTs

Table vii provides recommendations toward the use/non-use of each of the four common types of traffic control employed at CRTs for the state of Minnesota. Note that these recommendations do not necessarily relate to traffic control at the crosswalk within the CRT, except where noted.

Table vii. Recommended Traffic Control for CRTs

Traffic Control	Recommendation
Uncontrolled	The use of uncontrolled CRTs should be minimized in urban and suburban areas where non-motorized road users are expected to cross. Either removing or altering the traffic control at existing locations where these “free-right-turn” designs are employed represents an opportunity to advance the state’s safety goals by improving conditions for pedestrians and bicyclists.
Yield Control	Yield control represents the most common approach for single lane channelized right-turn facilities at signalized intersections in Minnesota. While there is a general perception among roadway agencies and vulnerable road users that traffic signal control provides the safest and most comfortable crossing experience, yield control can represent an acceptable configuration with appropriate design features and site-specific mitigation strategies. The R1-2 sign yield is typically placed at the downstream end of the channel in Minnesota, as shown in Figure 2A-3 of the Minnesota MUTCD [55]. It should be noted that the yield sign must not be placed at the crosswalk itself, as Minnesota state law requires that drivers “stop to yield” to pedestrians who are “crossing the roadway within a marked crosswalk or at an intersection with no marked crosswalk”. While not commonly used in Minnesota, advance yield pavement markings may also be included consistent with the Minnesota MUTCD [55]. It should be noted that the revised PROWAG requirements for multilane facilities [48] require a RRFB, PHB, or raised crossing if the CRT is not signalized.
Stop Control	While stop control may offer benefits to pedestrians and bicyclists at specific locations by enforcing a regulatory complete stop within the channel, this type of CRT control also negates many of the operational benefits afforded by the reduction in unnecessary stops at CRTs and may also be disregarded by drivers at locations with low pedestrian crossing activity. Nevertheless, stop control may represent a low-cost option to improve the crossing environment for pedestrians at locations where right-turning volumes are relatively low and moderate pedestrian volumes. However, confusion may be caused by the intent of the stop signs at CRTs as these signs are intended to control the vehicular conflict and are not intended to control the crosswalk upstream of the intersecting street.
Signal Control	Given the general perception among roadway agencies and other safety stakeholders that traffic signal control provides the safest and most comfortable crossing experience for pedestrians at CRTs, signal control is widely understood to be the traffic control alternative preferred by pedestrians. This is particularly true for pedestrians with disabilities, who desire signal control to be provided at the crosswalk itself and be of an accessible design. While signal control does not address many of the wayfinding concerns experienced by visually disabled pedestrians at CRTs, the protected crossing movement provided by the red indication represents an advantage over yield control for these users. Furthermore, the use of signal control at the crosswalk within a CRT satisfies the revised PROWAG requirements for multilane channelized facilities [48]. At most locations, vehicular signalization on the CRT would be used at both the CRT crosswalk and the cross street merge point, while some locations may include signalization only at the CRT crosswalk. It is also important to consider that given the short distance of the CRT crossing, it is likely that many pedestrians will opt to cross without activating the pedestrian phase, and in doing so, would be crossing in violation of a solid “Don’t Walk” signal indication and thus without the right-of-way normally afforded to crosswalk users. One option to remedy this is to allow the vehicular signal at the CRT crosswalk to dwell in a flashing

Traffic Control	Recommendation
	<p>yellow arrow or ball (rather than green), along with dark pedestrian indications, except when activated by a pedestrian. Doing so allows pedestrians to retain the right-of-way within the crosswalk without activation of the pedestrian phase.</p> <p>Signal phasing and timing for the overall intersection should place special emphasis on accommodating the pedestrian crossing movements. It is general practice to phase the pedestrian crossing at the CRT lane to run opposite of the phases for the conflicting right-turning traffic at the CRT, including through-traffic phases and any overlapped right-turn phases (e.g., right turns paired with protected left-turns on the cross street). It is worth noting that with a default phasing strategy, if all four quadrants of an intersection include a channelized right-turn lane, all directional pedestrian crossings would require two pedestrian phases to complete, which often increases the total pedestrian crossing time compared to crossings at traditional intersections without CRTs. Modern signal controllers often allow for pedestrian phases to be overlapped, which would allow for a pedestrian phase across the CRT lane to be paired with the directional left-turn movements, during which the conflicting right-turning traffic at the CRT would be stopped. Overlapped pedestrian phases provide the potential for more efficient pedestrian signal timing and reduced crossing times.</p> <p>The specifics of the traffic signal design (such as the selection or arrangement of signal heads) should be consistent with common practice at other non-channelized intersections. Common options for signal indications for CRT lanes include: 5-section heads with three circular indications and two arrow indications, 3-section heads with arrows only, 3-section heads with circular indications only, 4-section heads with arrows only (with flashing yellow arrows), and others. The choice of the signal head arrangement and signal indications is dependent on how the signal is phased. The placement of required accessible pedestrian signals (APS) at CRTs, which include tactile and audible features, requires careful consideration due to the atypical geometry of the CRT designs.</p> <p>If signalization is used for traffic control for the CRT movement, care should be taken to use signal timing strategies to help avoid vehicle-to-vehicle conflicts at the point where traffic from the CRT merges with downstream traffic from the main intersection. Potential strategies include longer clearance times for traffic approaching the merge conflict point from the main intersection or delaying the start of the CRT movement.</p>

Recommended CRT Design Features

Table viii provides a summary of recommendations related to CRT design features that influence safety and accessibility for non-motorized road users at CRTs.

Table viii. Recommended CRT Design Features

Design Feature	Recommendation
<p>Crosswalk Markings and Placement</p>	<p>The decision to include crosswalk pavement markings and the selection of the type of crosswalk markings (if used) represents a fundamental design consideration at CRTs. Given the challenging crossing environment presented by CRTs, the inclusion of high-visibility crosswalk markings, such as longitudinal bars, ladder, or bar pair markings, provides for a relatively low-cost enhancement to provide guidance to pedestrians with low vision and to remind drivers of the crossing location.</p> <p>All new or reconstructed CRT designs where pedestrians are expected to cross should include high-visibility crosswalk markings as a standard. While high-visibility crosswalk markings should also be incorporated as a component of safety projects to enhance existing locations, this should not be viewed as a standalone safety treatment. Guidance in the MnDOT <i>Traffic Engineering Manual</i> [56] to generally not install crosswalk markings at CRTs should be revised. While it is acknowledged that maintaining these pavement markings represents an increased cost for both MnDOT and local roadway agencies, the crossing environment should represent a focus of CRTs where pedestrians and bicyclists are expected to be present.</p> <p>It is important to recognize that the optimal crosswalk placement requires the consideration of site-specific geometric conditions and the flexibility provided within the Minnesota MUTCD [55]. However, the center-perpendicular placement, depicted in Option 3 in the following image, should be viewed as the default approach for CRTs (particularly for locations with yield control) and subsequently adjusted to fit site conditions. For example, downstream placements may be more appropriate for locations with signals that are positioned at the crossroad.</p> <div data-bbox="414 1060 1422 1806" style="border: 1px solid black; padding: 10px;"> <p style="text-align: center;">Examples of Crosswalk Placement Strategies within CRTs [1]</p> </div>

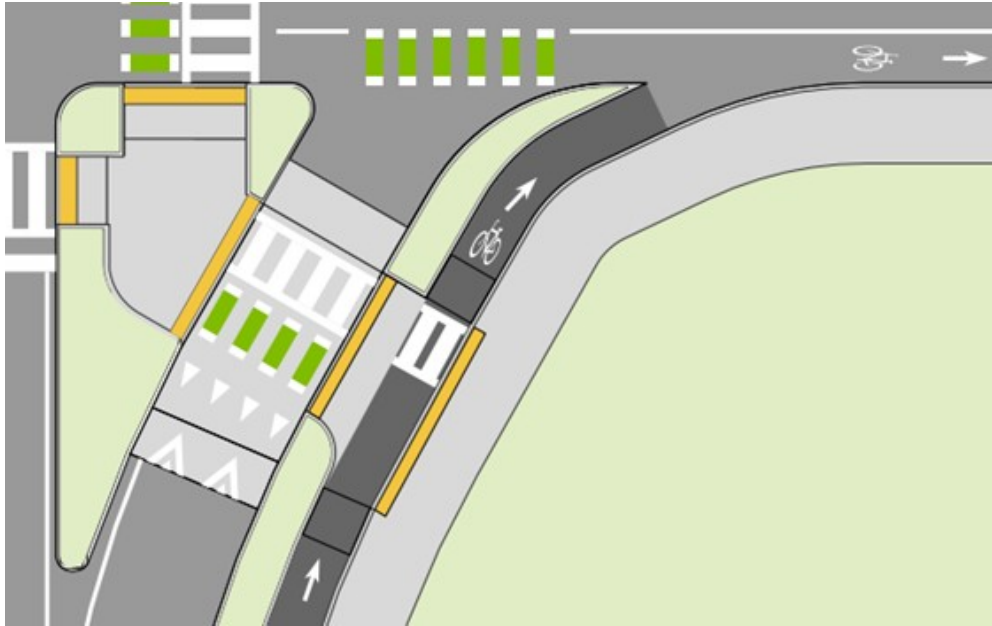
Design Feature	Recommendation
<p>Angle of Entry</p>	<p>Consistent with MnDOT’s <i>Bicycle Facility Design Manual</i> [52] and the <i>Facility Design Guide</i> [53], the modern low angle of entry design should be the standard approach for CRTs in Minnesota. All new and reconstructed channelized facilities should work towards the geometric design demonstrated below within the constraints of site-specific conditions. Additionally, both MnDOT and local agencies should proactively seek to retrofit existing CRTs with the modern low angle of entry approach as a systemic safety project. While there have been instances of drivers encroaching beyond the end of the channel into the cross street, local agencies noted that edgeline extensions have been used to address this concern.</p>  <p style="text-align: center;">Example of Modern Low Angle of Entry CRT Design [33]</p>
<p>Channelizing Island Design</p>	<p>The design of CRTs should consider how the size of channelizing islands and the related crossing paths influence safety and accessibility for non-motorized road users. Refer to the AASHTO Green Book [2] and Schroeder et al. [25] for detailed guidance with regard to island design, including appropriate size, crossing path through the island, and other geometric design principles.</p> <p>With respect to island size, the MnDOT <i>Bicycle Facility Design Manual</i> [53] suggests that channelizing islands should be large enough to store either bicycles with trailers or groups of bicyclists – including space that is at least six feet long but ideally at least ten feet long. The use of larger islands can help to ensure space for the required traffic control devices, pedestrian pathing, and bicycle storage. In general, at least 100 square feet is recommended in urban areas.</p> <p>It is critical to provide appropriate guidance through the channelizing island for pedestrians with vision disabilities and ensure that the area outside of the crossing path be identifiable as a non-walking surface, as islands without this guidance can be disorienting [25]. Both the cut through (i.e., level with the street) or ramped approaches to accommodating crossing paths through channelizing islands are acceptable options depending on the goals of the designer and site-specific conditions. However, the complications associated with snow removal have resulted in the ramped approach representing the preferred alternative in Minnesota. Given the importance of emphasizing consistency in CRT design, MnDOT and local agencies should work towards standardizing the preferred approach.</p>



Design Feature	Recommendation
Deceleration and Acceleration Lanes	<p>Deceleration lanes have generally been identified as positive for pedestrians and represent a commonly included design element at CRTs. All new and reconstructed designs should generally incorporate deceleration lanes. The use of CRTs should be minimized in design scenarios where the inclusion of a deceleration lane is infeasible due to site-specific conditions. Both MnDOT and local agencies should proactively seek to remove or retrofit existing CRTs without deceleration lanes where non-motorized road users are expected to be present.</p> <p>The use of acceleration lanes should be avoided due to the fact these designs are intended to increase operating speeds and reduce the driver expectation of yielding. Consistent with the AASHTO <i>Green Book</i> [2], the use of acceleration lanes should be generally limited to facilities where pedestrians are not expected to cross. This scenario would commonly include “free-right-turn” designs employed in rural areas. Acceleration lanes should not be included with new or reconstructed designs. Both MnDOT and local agencies should proactively seek to remove or retrofit existing CRTs with acceleration lanes where non-motorized road users are expected to be present.</p>



Mitigation Strategies for CRTs

Table ix provides recommendations for the use of mitigation strategies to enhance safety and accessibility at crossings within CRTs.

Table ix. Mitigation Strategies for CRTs

Strategy	Recommended Use
Raised Crosswalks	<p>The use of raised crossings at CRTs represents a potential enhancement option to consider that has been used successfully by state and local roadway agencies in a number of traffic control configurations. Raised crossings are also one of the treatments identified within the revised PROWAG requirements for multilane channelized facilities [48]. Raised crossings have previously been implemented in Minnesota in other roadway settings and are also identified in the Minneapolis <i>Street Design Guide</i> [34]. The MnDOT <i>Bicycle Facility Design Manual</i> [53] recommends the use of a raised crossing to improve the visibility of pedestrians and bicyclists. However, it must be noted that raised crossings are currently not allowed on state-aid routes in Minnesota.</p> <p>While roadway agencies have identified difficulties related to winter maintenance or buses bottoming out after passing over the facility due to the total height of the raised crossing, the grade break and ramp design can help to ensure the treatment is effective, even in cases where the total height of the raised crossing is relatively low. It is also critical to ensure that these designs consider how pedestrians with disabilities will interact with the crossing. For example, designs without any slope before the crosswalk or misaligned detectable warning devices can lead to potential confusion.</p>

Strategy	Recommended Use
<p><i>W11-2 Pedestrian Crossing Warning Signs</i></p>	<p>MUTCD W11-2 signs are one of the fundamental traffic control devices that can be used to supplement crossings at CRTs across several traffic control configurations. It should be noted that these devices should be used on a case-by-case basis as there may be site-specific situations where visual clutter represents a potential concern. In other words, W11-2 signs do not represent a standard treatment that should be included as a component of all CRTs in urbanized areas where pedestrians are expected to cross. Instead, these signs should be considered as one potential option to enhance the crossing in conjunction with other mitigation strategies</p> 
<p><i>R1-5 Yield/Stop Here for Pedestrian Signs</i></p>	<p>Historically roadway agencies have used R1-5 signs to enhance crossings at CRTs with a variety of design configurations. However, the 11th edition of the MUTCD limits the use of R1-5s to multilane applications [28]. The R1-5b/c “stop” variant of the signs therefore represents a potential option to consider at dual channelized right-turn lanes.</p> 
<p><i>R10-15 Turning Vehicles Yield/Stop Here for Pedestrian Signs</i></p>	<p>R10-15 signs are another regulatory sign that can be used to emphasize crossings at CRTs with a variety of design configurations. These signs may offer an alternative to R1-5s for single lane channelized facilities given the multilane restriction included in the 11th edition of the MUTCD [28].</p> 
<p><i>Pedestrian-Actuated Beacons or Warning Devices</i></p>	<p>Both rectangular rapid-flashing beacons (RRFBs) and pedestrian hybrid beacons (PHBs) can be used to enhance crossings at CRTs with yield control. It should be noted that both devices are included within the revised PROWAG requirements [48] as treatments to satisfy accessibility requirements for multilane facilities. Ultimately, the use of RRFBs or PHBs are site-specific treatments that should be considered as an alternative to signal control of the channelized lane.</p>
<p><i>Right Turn on Red Restrictions</i></p>	<p>Both static and dynamic Right Turn on Red (RTOR) restrictions can be considered to improve safety and accessibility for pedestrians at signalized CRTs where RTOR is otherwise allowed. It should be noted that recent research sponsored by the department has suggested that overall compliance rates are higher at locations with static No Turn on Red Treatments in a general setting [60].</p>

Strategy	Recommended Use
<p>Lane Narrowing, Radius Reductions, and Truck Aprons</p>	<p>Lane narrowing and radius reductions can also be used to address concerns at CRTs related to corner radii or excessively wide pavement cross-sections that allow for relatively high turning speeds. Treatments range from the use of bollards or cross-hatched pavement markings to a permanent modification of the curb line. While curblines modifications are the most desirable design alternative from a pedestrian perspective, bollards or pavement markings can also represent an improvement over existing conditions in certain circumstances. Bollards or cross-hatched pavement markings could also be used as a part of short-term demonstration projects. Radius reductions should generally be implemented on the right side of the channelized lane to achieve the maximum speed reduction effect on drivers. Mountable truck aprons may also be integrated along with radius reductions to better accommodate the turning requirement of large trucks, while still affording the intended speed reductions. However, it is critical to ensure that pedestrian ramp and crosswalk design accommodate the potential wayfinding and orientation challenges for pedestrians with vision disabilities.</p>  <p style="text-align: center;">Example of Lane Narrowing/Radius Reduction (with Truck Apron) [3]</p>
<p>Tactile Warning Surface Indicators</p>	<p>Tactile walking surface indicators, such as those depicted in the image below, are an emerging option to assist visually impaired pedestrians with wayfinding and orientation at crosswalks where typical cues used by visually impaired pedestrians (such as adjacent road noise or detectable edges) can be misleading.</p>  <p style="text-align: center;">Example of Tactical Walking Surface Indicators at a Roundabout [61]</p>
<p>Bicycle Lane Connections to Sideways</p>	<p>One innovative approach is to connect bicycle lanes with sidepaths upstream of the CRT to allow bicyclists who feel uncomfortable traveling within the roadway at these locations to move to facilities outside of the traveled way. However, it was noted during focus groups that such designs create potential conflicts between bicyclists entering from the roadway and pedestrians, which is of a particular concern for visually disabled pedestrians who may be struggling with wayfinding at the channelized right-turn lane.</p>

Chapter 1: Introduction

Channelized right turns (CRTs) are a common treatment employed at intersections throughout the United States and beyond to improve the operational performance for vehicular traffic. CRTs (**Figure 1**) increase vehicular capacity by increasing the turning speed and reducing unnecessary stops [1]. The American Association of State Highway and Transportation Officials (AASHTO) *Green Book* [2] recognizes that CRTs can enhance both operational and safety performance when used in appropriate settings.



Figure 1. Example a signalized intersection with channelized right turns (CRTs) in Austin, Texas [3].

However, while CRTs may provide operational and safety benefits for drivers, they present potential accessibility and safety issues for bicyclists and pedestrians attempting to cross, particularly those with vision impairments or other disabilities, due to the indirect crossing path and high right-turn speeds accommodated by the larger turning radius. Furthermore, many CRTs are uncontrolled, which creates additional safety issues for pedestrians and bicyclists attempting to cross. Given the potential concerns for pedestrians, bicyclists and other active transportation modes, agencies throughout the United States have sought to identify improved methods for right-turn channelization that better accommodate the safety and accessibility needs for all road users. This includes agencies within Minnesota, where nearly 900 fatal and serious injury crashes occur annually at intersections and interchanges, along with greater than 200 pedestrian-involved fatal and serious injury crashes [4].

The identification of best practices for use of CRTs can help to support development of improved guidance toward their use and further advance the safety performance goals of the Minnesota *Strategic Highway Safety Plan* [5]. This includes identifying appropriate contexts for the use of CRTs along with effective design strategies to accommodate safety and accessibility for all road users. Implementation of these strategies will help to promote walkable communities that enhance equity, quality of life, and economic efficiency consistent with MnDOT's *Statewide Pedestrian System Plan* [6].

1.1 Research Objectives and Methods

This research, *Pedestrian Safety and Accessibility Best Practices for Channelized Right-Turn Lanes (NS-694)*, sought to identify best practices for right-turn channelization to better accommodate the safety and accessibility needs for all road users. Emphasis was placed on identifying design elements that can be used to mitigate potential safety and accessibility concerns for vulnerable road users, particularly persons with vision impairments or other disabilities. The ultimate goal of this effort was to prepare a series of recommendations for MnDOT and local roadway agencies to consider toward employing CRTs in a manner consistent with the *Safe System Approach* [7]. The process to identify best practices and develop recommended guidance for the use of CRTs in Minnesota is shown in **Figure 2**.

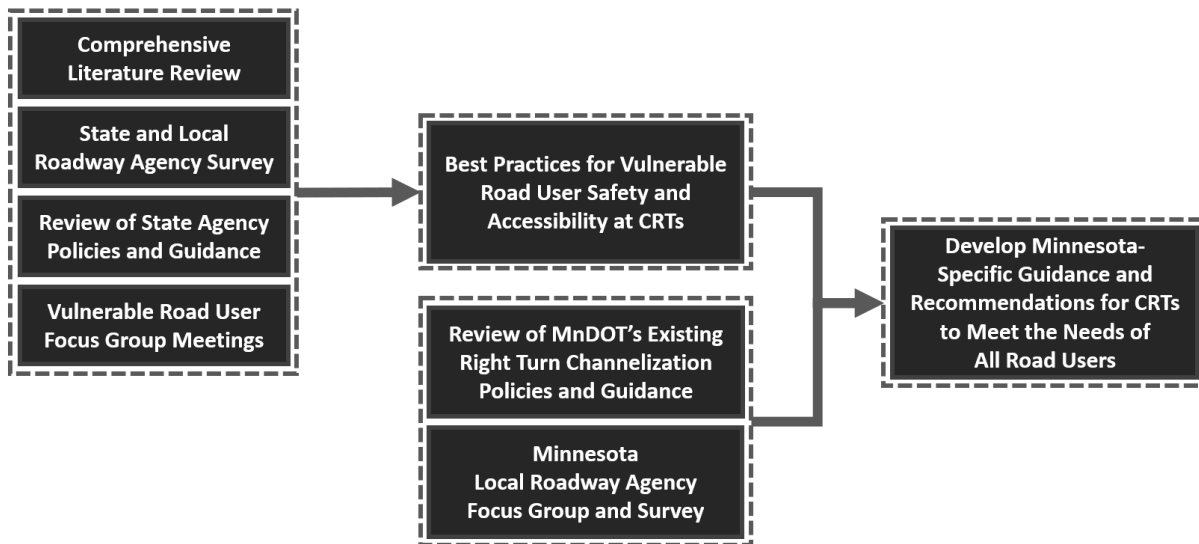

Figure 2. Process to identify best practices and develop recommended guidance for CRTs in Minnesota.

Initially, a comprehensive literature review was conducted to identify design and traffic control strategies specific to CRTs with a focus on how these elements affect pedestrians. The findings of the literature review were used to develop a subsequent online state-of-the-practice survey, which was distributed to state and local roadway agencies across the United States. A review of state agency policies and guidance related to CRTs was conducted, in addition to a review of current practice in Minnesota. The research team also hosted a series of focus group meetings with vulnerable road users, including pedestrians, bicyclists, and disabled persons to obtain targeted feedback related to navigating CRTs along with recommended improvements. The findings resulting from these tasks were synthesized to develop conclusions and recommendations related to the design and implementation of CRTs within Minnesota to mitigate potential safety and accessibility concerns for vulnerable road users, particularly persons with vision impairments or other disabilities. The remainder of this report is structured as follows:

- **Chapter 2:** Literature Review
- **Chapter 3:** Current Practice in the United States
- **Chapter 4:** Current Practice in Minnesota

- **Chapter 5:** Vulnerable Road User Focus Groups
- **Chapter 6:** Conclusions and Recommendations

Chapter 2: Literature Review

A literature review was conducted during the early stages of the project. The reviewed documents included research reports from Federal Highway Administration (FHWA), US Department of Transportation (USDOT), National Cooperative Highway Research Program (NCHRP), state DOTs, and other agencies. Research articles published in peer-reviewed journals and conference proceedings were also reviewed. Relevant publications were identified using the Transport Research International Documentation (TRID) bibliographical database and other relevant search engines. **Section 2.1** provides an overview of general planning and design concepts for CRTs with a focus on how these elements affect pedestrians and bicyclists. **Section 2.2** provides a summary of design features and mitigation strategies for pedestrian and bicyclist accommodation that have been evaluated in prior work.

2.1 General Planning and Design Considerations

This section summarizes the literature on planning and design characteristics for CRTs, with a specific focus on the impacts to pedestrians and bicyclists. A significant amount of prior research has evaluated how various CRT designs affect both motorized and non-motorized road users. Several prior efforts have evaluated driver, pedestrian, and bicycle behavior at CRTs [8-14]. Additionally, there are a number of efforts that have evaluated the safety performance of CRTs or specific design aspects of these facilities [15-21]. Prior research has established a number of primary reasons that CRTs are utilized [1, 2], which include:

- Increases vehicular capacity;
- Reduces driver delay, fuel consumption, and emissions due to reduced stopping and increased turning speeds;
- Improves definition of the right-turning path at intersections with skew or unusual geometry;
- Improves accommodation for right-turning trucks due to the larger radius
- Potentially improves safety through separation of right turn conflict points;
- Provides refuge for pedestrians crossing wide or heavily skewed intersections

National design guidance for CRTs can be found in the *Green Book* [2] as well as AASHTO's pedestrian [22] and bicycle [23] guides. It should be noted that the 4th edition of AASHTO's bicycle guide was published in 2012 and an upcoming revision may provide updated guidance specific to CRTs. **Table 1** summarizes the key nationwide research efforts related to planning and design of safer CRT facilities. Additional details related to the operational impacts of CRTs can be found in within references [1, 15].

Table 1. Summary of Key National References for CRT Planning and Design

Study	Summary
NCHRP Report 279: <i>Intersection Channelization Guide</i> (1985) [24]	Foundational effort that provides principles and criteria for the use of channelization at intersections. The work included a review of current practice, field studies, and the development of guidelines for implementing channelization at intersections.
NCHRP's <i>Synthesis on Channelized Right Turns at Intersections on Urban and Suburban Arterials</i> (2006) [1]	Synthesis document developed as a part of NCHRP Project 3-72 that aggregated prior literature and agency practices specific to CRTs. This included a comprehensive literature review and a survey of roadway agency practice. The synthesis provides a detailed review of geometric design, traffic control, operations, and safety considerations.
NCHRP Report 674: <i>Crossing Solutions at Roundabouts and Channelized Turn Lanes for Pedestrians with Vision Disabilities</i> (2011) [14]	NCHRP Report 674 that includes guidance for practitioners to establish safe crossings at roundabouts and CRTs, including conditions that may present concerns, potential treatments, and methods for conducting related studies.
NCHRP Web-Only Document 208: <i>Design Guidance for Channelized Right-Turn Lanes</i> (2014) [15]	Web-Only Document 208 provides design guidance for CRTs in a manner that balances the needs of both motorized and non-motorized road users. This guidance was developed based on the findings of field evaluations, interviews with mobility specialists, an operational evaluation, and a safety performance evaluation.
NCHRP Research Report 834: <i>Crossing Solutions at Roundabouts and Channelized Turn Lanes for Pedestrians with Vision Disabilities</i> (2017) [25]	NCHRP Research Report 834 (in addition to the final project report published as Web-Only Document 222 [26]) is a guidebook that provides strategies to accommodate pedestrians with vision disabilities at roundabouts and channelized turn lanes. This includes both an assessment framework as well as methods to evaluate potential design alternatives. Core to this work is the difference between overall accessibility (independent of crash data) versus observed safety performance.

2.1.1 Pedestrian Considerations

The primary advantage of CRTs for pedestrians is the refuge provided by the channelizing island that is particularly beneficial when crossing wide or heavily skewed intersections. However, there are also several potential disadvantages for pedestrians associated with these designs that impact safety, accessibility, and/or mobility. NCHRP Research Report 834 *Crossing Solutions at Roundabouts and Channelized Turn Lanes for Pedestrians with Vision Disabilities* [25] identified potential advantages and disadvantages of CRTs specific to pedestrians, shown in **Figure 3**.

Advantages	Disadvantages
<ul style="list-style-type: none"> • Island serves as a refuge for pedestrians. • Compared to crossings having a conventional right-turn lane, the length of the main crosswalk is shorter. • Right turn on red maneuvers are removed from the main crosswalk spanning through and left lanes. • Right turn on green maneuvers are removed from the main crosswalk spanning through and left lanes. • Larger turn radii can decrease the likelihood of large vehicles encroaching or off-tracking onto sidewalks. 	<ul style="list-style-type: none"> • In most cases, the crossing of the CTL is unsignalized. • Pedestrians must make decisions about the speed of vehicles and driver yielding behavior • Channelization may enable higher speeds for right-turn vehicles • Curvature of the channelized lane may create sight distance and visibility issues for drivers and pedestrians. • Crosswalk location varies and angles may be confusing for pedestrians with vision disabilities. • Drivers may be focused on conflicting traffic and searching for gaps rather than focusing on pedestrians.

Figure 3. Advantages and disadvantages of CRTs for pedestrians (Table 5-1 - NCHRP Research Report 834) [25].

Unfortunately, many of the design strategies that are beneficial for most pedestrians may represent potential concerns for pedestrians with vision disabilities [25]. Blind pedestrians must complete four tasks in order to safely cross roadway facilities, including [14]:

- Identify the crosswalk and intended crossing location.
- Correctly align an initial heading to traverse the crosswalk, including scenarios where the crosswalk may not be perpendicular to the sidewalk.
- Determine the appropriate time to complete the crossing movement. This may be particularly challenging when uninterrupted traffic flow is present, and pedestrians must identify safe gaps or identify crossing opportunities created by yielding vehicles.
- Maintain the correct alignment across the entire length of the roadway.

CRTs represent a unique challenge to pedestrians with vision disabilities due to the fact many of these crossings are unsignalized and vehicle trajectories are often curved [14] in an environment where turning speeds can reach up to 30 miles per hour depending on the geometry [14]. This is further complicated by the fact that drivers may be looking for gaps along the intersecting roadway to complete merging movements downstream [14]. Field evaluations conducted by Schroeder et al. [14] suggested that drivers often do not yield for pedestrians waiting at the curb for a safe gap to cross at CRTs (or approximately 15 percent) and speeds can be higher when there was not an expectation of conflicting traffic along the intersecting roadway. It should be noted that during these field evaluations, the research team intervened to pull back a blind pedestrian participating in the study between 5 and 10 percent of the time to avoid potential collisions [14]. Research conducted by Tarawneh and McCoy [27] has also provided evidence that turning speeds are higher at intersections with CRTs and drivers are also much less likely to stop before completing right turn on red movements when compared to conventional intersections.

2.1.2 On-Road Bicyclist Considerations

The integration of on-road bicycle facilities with CRTs presents potential issues for bicyclists. The literature suggests that accommodation of bicyclists at CRTs should consider three specific scenarios for potential vehicular conflict [1]:

- The weaving movement that must be completed by drivers entering the right-turn lane across space where bicyclists may be traveling straight through the intersection.
- Bicyclists utilizing the channelized lane to complete right-turn movements.
- Drivers completing right-turn movements must weave across space where bicyclist traffic may be present along the intersecting street.

The Manual on Uniform Traffic Control Devices (MUTCD) [28] and AASHTO's *Guide for the Development of Bicycle Facilities* [23] provide guidance for marking bicycle lanes at intersections with right-turn lanes from a national perspective. It should be noted that there is limited published guidance related to accommodating shared-use paths at CRTs.

2.1.3 Types of Traffic Control for Vehicular Movements

Vehicular traffic control at CRTs is generally considered to be independent of the main intersection, and it follows that all vehicular traffic control at the CRT is intended solely for the channelized right-turn movement [1]. While there are a number of possible geometric and traffic control configurations, the vehicular traffic control used at CRTs is typically either yield controlled, stop controlled, signal controlled, or uncontrolled (**Figure 4**). While there is limited research to quantify the safety performance of these alternatives, the type of traffic control employed at CRTs has a considerable impact on the safety and accessibility for pedestrians and bicyclists attempting to cross the CRT [1]. A survey of practitioners from state and local roadway agencies conducted in 2012 suggested that there is a perception that signal control offers the greatest safety performance [29]. Potts et al [15] provides design guidance for typical CRT scenarios for each type of traffic control.



Figure 4. Examples of four common types of vehicular traffic control at CRTs [3].

2.1.4 Geometric Design Considerations

While the *Green Book* [2] represents the primary reference for guidance regarding the geometric design of turning roadways in the United States, the AASHTO design guides for Pedestrian [22] and Bicycle [23] facilities provide guidance related to accommodating non-motorized road users at channelized lanes. Many of the key national reference documents previously identified in **Table 1** also provide detailed information with respect to the geometric design of channelized turn lanes and potential impacts to pedestrians and bicyclists. **Table 2** summarizes the fundamental geometric design elements of CRTs and related impacts to pedestrians and bicyclists.

Table 2. Summary of CRT Geometric Design Elements Impact on Pedestrian and Bicyclists

Element	Summary
Design Speed	The selection of design speed for CRTs should consider both motorized and non-motorized modes of travel [1]. This concept is particularly important as accommodating higher turning speeds is a primary operational advantage for CRTs from a vehicular perspective, while presenting potential safety concerns to pedestrians and bicyclists [1].
Radius, Entry Angle and Superelevation	The selection of an appropriate turning radius is a principal control of CRT design, where larger turning radii can help to accommodate large trucks while potentially increasing crossing distances for pedestrians [1]. The angle between the channelized facility and the intersecting street also represents a critical design component, as prior guidance has suggested that this impacts both driver speed selection and sight distance [15, 18]. While the <i>Green Book</i> recommends as much superelevation as is practical [1, 2], the presence of crosswalks may limit grades for these facilities [1].
Width	The width of channelized right-turn lanes represents another critical design control, where wider channels can help to accommodate large trucks but also result in longer pedestrian crossing distances [1].
Deceleration or Acceleration Lanes	Agencies often include speed-change lanes at CRTs in order to minimize vehicles accelerating or decelerating in through lanes [1]. The inclusion of either deceleration or acceleration lanes represents important design control for CRTs that have the potential to influence driver speed selection and yielding behavior [1, 25].
Channelizing Islands	Channelizing islands in between the main traffic stream and the right-turn movement are generally triangular in shape with sides that may be curved consistent with the geometric design [1]. These areas provide important refuge areas for pedestrians and require curb ramps or cut-throughs with truncated dome detectable warning devices for visually impaired pedestrians [1, 2, 25].

2.1.5 Safety Performance

Despite the fact that several prior studies have evaluated the safety performance of CRTs and related design elements [15-21], there remains a need for more information as to the safety performance impacts of these facilities. This is particularly true with respect to safety performance for pedestrians and bicyclists as well as the myriad of jurisdiction-specific design strategies employed by roadway agencies.

Prior research conducted by Dixon et al [16] indicated that the use of islands for right-turn movements reduced right angle crashes and the presence of an acceleration lane on the cross street without traffic control did not impact rear end crashes. Fitzpatrick et al [17] evaluated the crash history of various right-turn lane designs in Texas and determined that shared through and right lanes outperformed the channelized design in terms of total crashes. However, the authors noted that the impacts of right-turn traffic volumes were not adequately considered and additional research is needed.

Research conducted by Potts et al [15] suggested that the motor-vehicle crash experience was similar at four-leg signalized intersections with exclusive right-turn lanes, shared through and right-turn lanes, and channelized right-turn lanes. While it is critical to recognize that there is an important difference

between safety performance for pedestrians and accessibility [25], the research conducted by Potts et al [15] demonstrated that four-leg signalized intersections with conventional exclusive right-turn lanes experienced considerably higher frequencies of pedestrian crashes than intersections with either channelized or shared right turns. It should be noted that this work controlled for both vehicular and pedestrian volumes at the study intersections.

Schattler et al [18] evaluated the safety performance of a modified CRT design that was implemented at intersections in Illinois. This involved a reduction in the skew angle of the approach, which was intended to improve sight lines for drivers and reduce turning speeds through the channelized lane. The researchers evaluated the treatment safety performance via the empirical Bayes method, which indicated a 59.0 percent reduction in all traffic crashes along the subject approach and a 59.6 percent reduction in rear end collisions along the subject approaches. Other research [19, 20] has also investigated the impacts of similar modified CRT designs (**Figure 5**), sometimes referred to as “smart” right turns, with results that are in general agreement with Schattler et al [18].

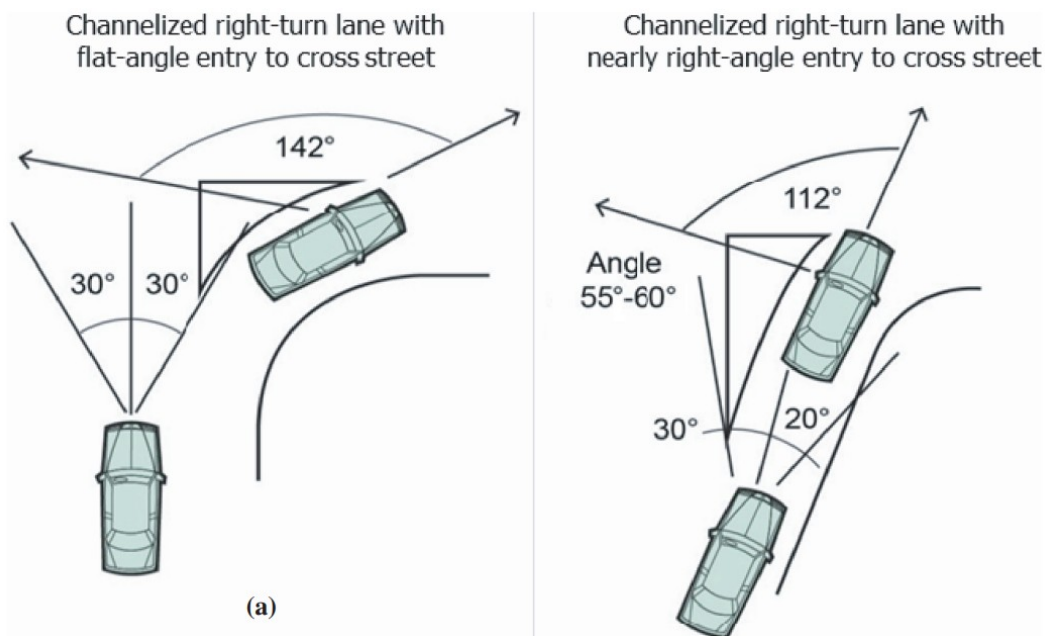

Figure 5. Conventional high angle (Left) vs. modern low angle (right) of entry island design at CRTs [25].

Research conducted by Ukkusuri et al [21] investigated several right-turn lane configurations, including CRTs, using data from Indiana. The findings indicated that safety performance from a general perspective was influenced by the geometric design, traffic control, speed limit, and traffic volume.

Ultimately, the limited literature related to the safety performance of CRTs makes it difficult to compare the safety impacts between the various CRT designs and between CRTs and conventional right-turn lanes, particularly for non-motorized road users. While research has demonstrated [18-20] that the improved visibility and reduced speeds associated with the reduced skew angle design reduces total and rear end crashes, the impacts on pedestrian-involved crashes remains unclear. Given the range of traffic

control and geometric characteristics associated with CRTs, quantifying the effects of these designs on pedestrian and bicycle safety performance requires research that is beyond the scope of this project.

2.2 Design Features and Mitigation Strategies

Road agencies across the United States have implemented a range of design features and strategies to mitigate concerns related to vulnerable road users at CRTs. The following sections provide a summary of the findings in the research literature related to the effects of various design features and mitigation strategies that have been implemented at CRTs.

2.2.1 Crosswalk Surface Treatments

A number of improvements to crosswalk surfaces have been implemented to enhance safety and mobility for pedestrians and bicyclists crossing at CRTs. This has typically included high-visibility crosswalk markings, advance yield markings, textured crosswalks, and raised crossings.

2.2.1.1 High-Visibility Crosswalk Markings

While the MUTCD provides for a number of crosswalk marking patterns [28], high-visibility crosswalk markings (**Figure 6**) are preferred – particularly at uncontrolled crossings [30]. Schroeder et al [25] notes that for pedestrians with a low level of vision have stated preferences for ladder markings as the transverse lines allow for them to follow the crossing path more easily. Prior work has also demonstrated that high-visibility crosswalk markings were associated with an increase in drivers yielding to pedestrians compared to conventional markings [31]. An example of high-visibility ladder markings used at a CRT is shown in **Figure 7**.

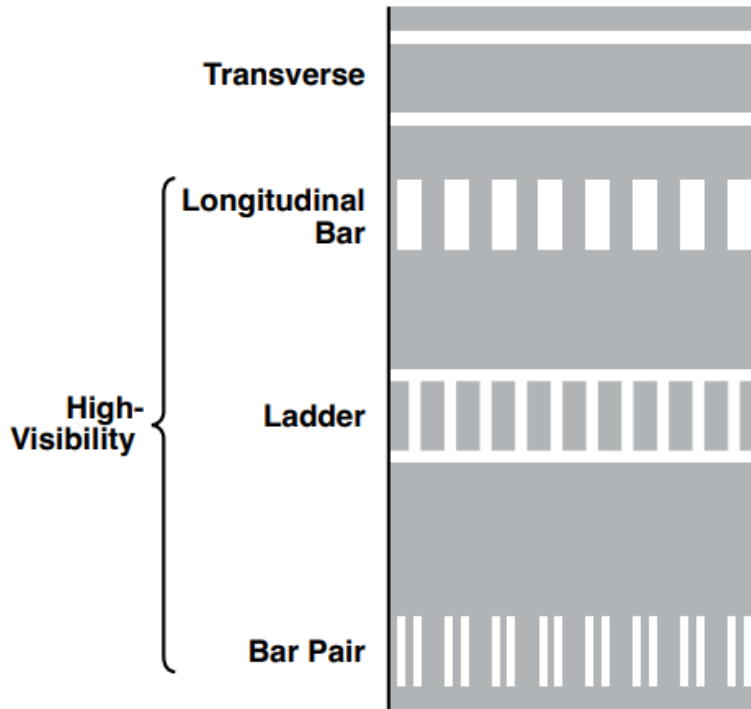

Figure 6. Crosswalk pavement markings (Figure 3C-1 from the MUTCD) [28].



Figure 7. Example of high-visibility crosswalk pavement markings at CRTs [3].

2.2.1.2 Advance Yield Markings

Advance yield or stop bar pavement markings (**Figure 8**) represent another potential option that agencies can consider at CRTs depending on the traffic control configuration. Prior research has demonstrated that the use of advance yield or stop markings and related signs at uncontrolled pedestrian crossings reduced vehicle-pedestrian collisions by 25 percent in a general setting [32].



Figure 8. Example of advance yield markings at CRTs [3].

2.2.1.3 Textured Crosswalks

Textured crosswalks, which are formed using a texturized pattern that is typically imprinted into the crosswalk surface, have been used as a crosswalk enhancement by roadway agencies at CRTs in urbanized areas across the country. Examples of textured crosswalks used at CRTs with yield and stop control are shown in Figure 9.



Figure 9. Examples of textured crosswalks at CRTs [3].

2.2.1.4 Raised Crossings

Prior work [13, 33] has suggested the use of raised crosswalks for channelized turns (Figure 10) as a traffic calming treatment that may provide a continuous accessible travel path for pedestrians and bicyclists. Raised crossings have previously been implemented in Minnesota in other settings and are also identified in the Minneapolis Street Design Guide [34]. Schroeder et al [25] notes that these treatments can help to assist pedestrians with vision disabilities to stay within the crosswalk.



Figure 10. Example of raised crossing at a CRT [3].

2.2.2 Crosswalk Placement

Beyond the details provided in the MUTCD that apply to markings for crosswalks [28], roadway agencies across the United States have employed a range of designs with respect to crosswalk location at CRTs. While common crosswalk placement options are presented in **Figure 11**, a crosswalk could theoretically be placed anywhere along the channelized facility [1]. A prior survey of roadway agencies conducted in 2006 indicated that the majority of state (77 percent) and local (67 percent) agencies employ crosswalks in the center position [1].

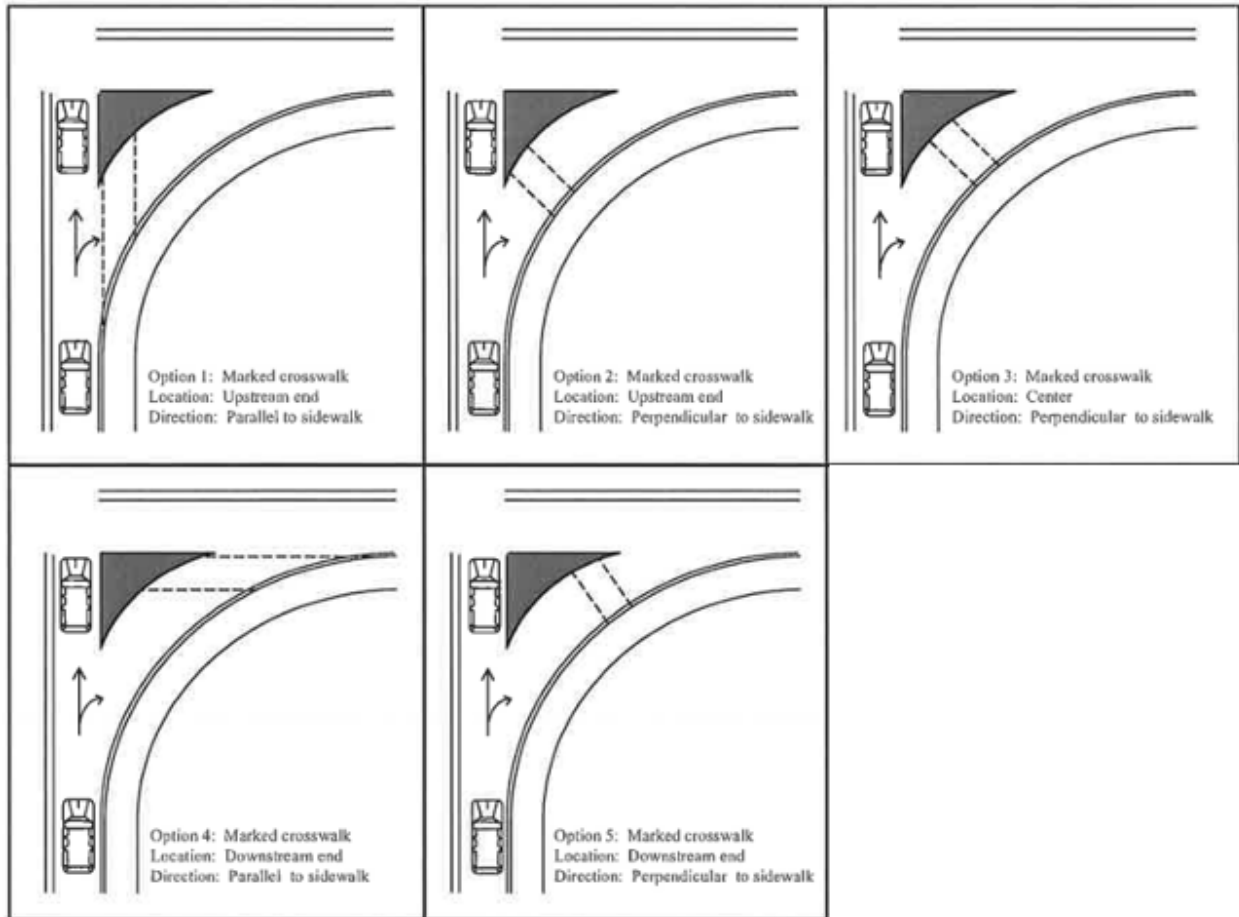

Figure 11. Examples of crosswalk placement options for CRTs [1].

Potts et al. [1] suggested that there could be competing objectives with respect to the alignment of crosswalks at CRTs, as parallel crosswalk designs may be preferred by visually impaired pedestrians while perpendicular crosswalks designs may be more beneficial for wheelchair users as it may allow for easier construction of ramp facilities. The FHWA's *Highway Design Handbook for Older Drivers and Pedestrians* has suggested that upstream placements are desirable to ensure that the driver's focus is on pedestrians prior to identifying gaps on the cross street [35]. Pedestrians with vision impairments may prefer downstream placement, as the sound from cross street traffic provides an audible indication that vehicles in the channel may not try to complete a movement if there is not a gap present [1].

Research conducted by Schroeder et al. [26] found that it is important for crosswalks to meet the island at the approximate center to maximize the adjacent surface area in order to avoid pedestrians with vision disabilities missing the island. Further work by Schroeder et al [25] identified several principles to balance when considering crosswalk location:

- Crosswalks across channelized facilities should minimize out-of-direction travel to the crosswalk for non-channelized lanes.

- Crosswalks should minimize exposure of pedestrians to traffic by minimizing the overall crossing distance.
- Pedestrians need visibility of oncoming vehicles to identify safe gaps and drivers need visibility of the crosswalk to identify pedestrians.
- Drivers also require visibility of traffic control devices specific to the crosswalk (such as the use of RRFBs or PHBs).
- Positive wayfinding guidance is important for any design.
- The channelizing island design should match the curbside landing.
- Designs should attempt to separate decision points for drivers between interacting with crossing facilities and identifying gaps in cross street traffic.
- Vehicle speed through the channelized facility is a key consideration for pedestrians and bicyclists as speed impacts both yielding behavior and the severity of collisions when they occur.

Ultimately, Schroeder et al [25] suggests that the center position (**Figure 12**) is optimal when this design is feasible for several reasons that influence the potential safety performance. Mobility specialists interviewed by Potts et al [15] did not indicate a preference for crosswalk location but did note that consistency was a key consideration.



Figure 12. Examples of center-perpendicular crosswalk placement at CRTs [3].

2.2.3 Traffic Control Devices

A range of warning signs and pedestrian actuated beacon treatments have been implemented by road agencies to enhance crossings at CRTs beyond the typical required traffic control devices incorporated within these designs. A summary of the effects of these treatments at CRTs, as documented in the literature, is provided in the following sections.

2.2.3.1 Signing Strategies

The MUTCD [28] provides for several pedestrian crossing warning and regulatory signs that can be considered to enhance crossings at CRTs depending on the specifics of the design and state law (Figure 13). W11-2 *Pedestrian Crossing Warning* signs represent the most common crosswalk signing enhancement for CRTs used by state and local roadway agencies in the United States. R1-5 *Yield Here to or Stop Here for Pedestrians* signs can also be considered when yield or stop lines are used in advance of a marked crosswalk across multilane uncontrolled approaches [28]. Roadway agencies have also historically used R1-6 *In-Street Pedestrian Crossing* signs in a variety of configurations that are intended to indicate the optimal location for crossing and reinforcing the requirement for drivers to yield the right-of-way [36]. Prior research has consistently demonstrated that these signs increase yielding compliance and lower vehicle speeds in other contexts [37-42]. R10-15 *Turning Vehicles Yield to/Stop for Pedestrians* signs can be considered to emphasize crossings at CRTs with a variety of design configurations. These signs may offer an alternative to R1-5s for single lane channelized facilities given the multilane restriction included in the 11th edition of the MUTCD [28].

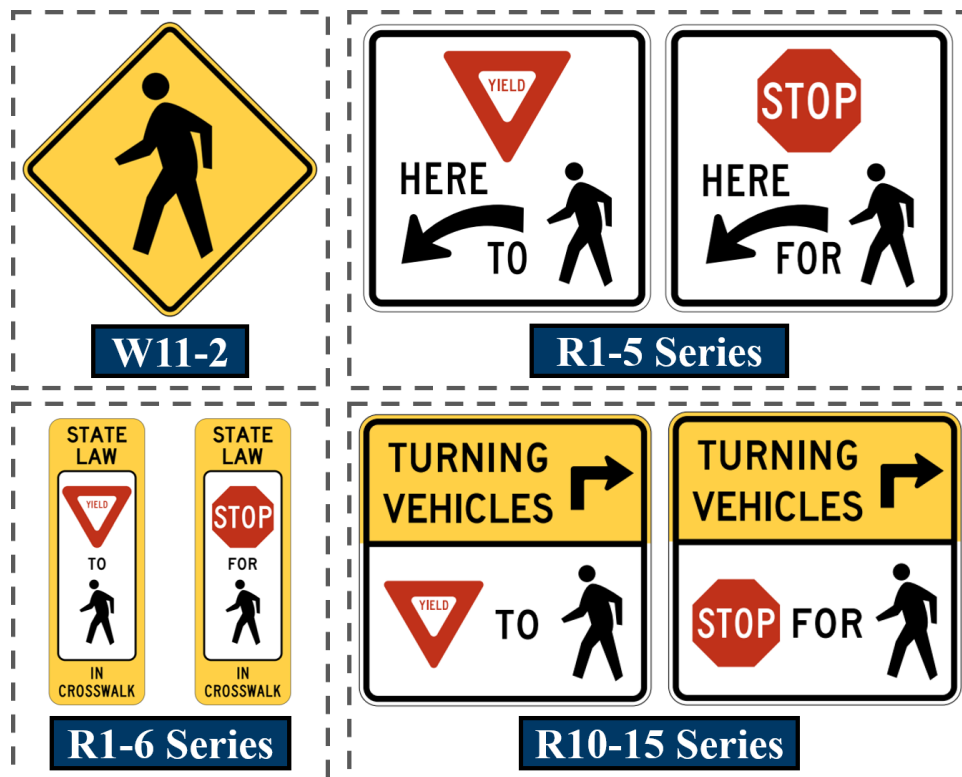

Figure 13. MUTCD pedestrian crossing signs commonly used at CRTs [28].

2.2.3.2 Pedestrian Actuated Beacons

Roadway agencies have also used various pedestrian-actuated beacons and other warning devices to improve safety at unsignalized crossings, including conventional flashing amber beacons, rectangular rapid-flashing beacons (RRFBs), pedestrian hybrid beacons (PHBs), and conventional pedestrian signals.

Guidance from Schroeder et al [25] notes that both RRFBs and PHBs (**Figure 14**) have potential roles at CRTs. RRFBs are pedestrian-actuated conspicuity enhancements that are used in conjunction with other devices to improve the safety performance of uncontrolled crossings [43]. PHBs are a special type of hybrid beacon that consists of two red lenses above a single yellow lens intended to both warn and control traffic at unsignalized marked crosswalks [28, 43]. Both devices have been associated with pedestrian crash reductions and increases in yielding compliance in a variety of roadway environments [32, 40, 44-47]. While Schroeder et al [26] noted that blind pedestrians gained confidence with RRFBs and PHBs, these devices must also be equipped with audible information devices in order to be used effectively. Schroeder et al [26] also recommends that PHBs may be a good option for CRTs with yield control as it does not include a green indication that could potentially be confused with the yield sign. Schroeder et al. [13] evaluated the use of pedestrian-actuated flashing amber beacons as a means to increase the rate of drivers yielding to pedestrians at CRTs. These devices, in combination with on-pavement sound strips, increased the driver yielding rate from 15.2 to 22.0 percent and reduced the rate of collision avoidance interventions by the research team with the visually impaired pedestrians.



Figure 14. Examples of RRFBs and PHBs used at CRTs or roundabouts [3, 33].

2.2.3.3 Accessibility Standards

Accessible pedestrian signals can help to provide additional information to pedestrians with vision impairments about related traffic patterns [13]. Paragraph 306.5 of the U.S. Access Board’s *Public Right-of-Way Accessibility Guidelines* (PROWAG) [48] states that multilane crossings, including those at CRTs, “shall provide treatments consisting of one or more of the following: a traffic control signal with a

pedestrian signal head; a pedestrian hybrid beacon; a pedestrian actuated rectangular rapid flashing beacon; or a raised crossing". The inclusion of such treatments at multilane crossings is largely to reduce multiple threat conflicts and collisions, which occur when a yielding vehicle in the near lane obstructs the view of the adjacent lane. Notably, PROWAG does not include standards for treatments or signalization at single lane channelized facilities [25]. Schroeder et al [25] recommended that pushbuttons and accessible signals be placed downstream of the crosswalk to ensure they are not located between pedestrians and oncoming vehicles.

2.2.3.4 Signal Timing Strategies

While there is limited research into signal timing strategies at CRTs that can improve safety and mobility for pedestrians, this may represent one potential avenue to mitigate the concerns outlined in **Section 2.1**. Signal phasing and timing for the overall intersection should place special emphasis on accommodating the pedestrian crossing movements. It is general practice to phase the pedestrian crossing at the CRT lane to run opposite of the phases for the conflicting right-turning traffic at the CRT, including through-traffic phases and any overlapped right-turn phases (e.g., right turns paired with protected left-turns on the cross street). It is worth noting that with a default phasing strategy, if all four quadrants of an intersection include a channelized right-turn lane, all directional pedestrian crossings would require two pedestrian phases to complete, which often increases the total pedestrian crossing time compared to crossings at traditional intersections without CRTs. Modern signal controllers often allow for pedestrian phases to be overlapped, which would allow for a pedestrian phase across the CRT lane to be paired with the directional left-turn movements, during which the conflicting right-turning traffic at the CRT would be stopped. Overlapped pedestrian phases provide the potential for more efficient pedestrian signal timing and reduced crossing times.

Leading pedestrian intervals (LPIs) have shown success in a number of signalized intersection contexts [49]. This treatment typically involves providing pedestrians with an opportunity to enter the crosswalk three to seven seconds before vehicles are provided with a green indication [49]. While there is no prior work that has established the impact of this treatment for intersections with CRTs, leading pedestrian intervals have been shown to increase visibility for pedestrians in the crosswalk, reduce potential conflicts, increase yielding rates, and improve safety for pedestrians that may need more time to cross. While Schroeder et al. [13] has suggested that exclusive pedestrian phases are unlikely to be an option to apply to CRTs, this treatment has been implemented in a variety of other contexts [22, 50].

2.2.3.5 On-Pavement Sound Strips

Schroeder et al. [13] evaluated the use of on-pavement sound strips (**Figure 15**) intended to provide audible information to pedestrians by emitting a "clack" noise when traversed by a vehicle within the turn lane. These devices were successful at reducing the number of interventions by the research team to avoid potential collisions, a finding that was also present when combined with a flashing beacon. However, the authors noted that more research is needed to determine if this is an effective treatment. Although these treatments have shown promise, they are likely not a viable option in areas that utilize snow plows.



Figure 15. Example of on-pavement sound strips at CRTs [25].

2.2.4 Geometric Design Strategies

As discussed in **Table 2** with **Section 2.1.4**, there are several fundamental geometric design elements of CRTs that influence safety and accessibility for non-motorized road users. Roadway agencies have therefore developed strategies related to these geometric design elements to maximize safety, mobility, and comfort for all road users. The following sections provide details on the effectiveness of various geometric design strategies as noted in the research literature.

2.2.4.1 Island Design

Both the AASHTO *Green Book* [2] and Schroeder et al [25] provide detailed guidance with regard to island design, including appropriate size, crossing path through the island, and other geometric design principles. It is critical to provide appropriate guidance through the channelizing island for pedestrians with vision disabilities and ensure that the area outside of the crossing path be identifiable as a non-walking surface as islands without this guidance can be disorienting [25]. Crossing paths through channelizing islands are typically either cut through (or level with the street) or ramped [25], as shown in **Figure 16**. In research by Schroeder et al [25], participants indicated a preference for the ramped design as it provided an additional indication that they had reached the island (in addition to detectable surfaces). Conversely, mobility specialists interviewed by Potts et al [15] indicated a preference for the cut through design. Curbed channelized islands are preferred over painted approaches for pedestrians as they more clearly define the boundary with the traveled way to provide refuge [1].

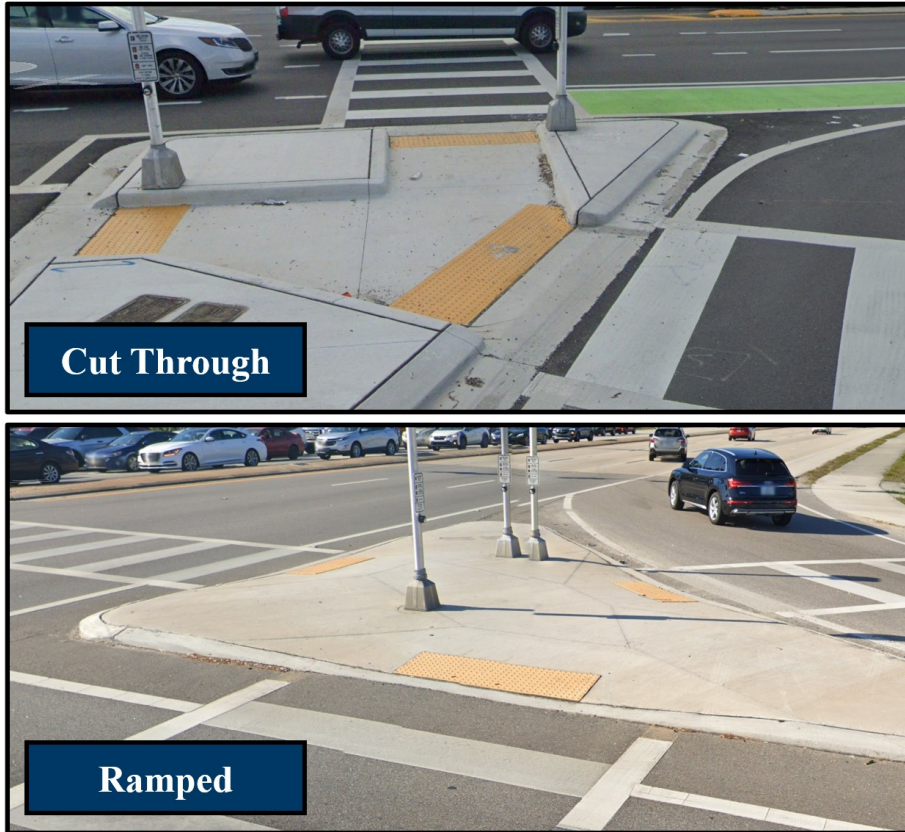

Figure 16. Example of cut through and ramped approaches to island design at CRT [3].

2.2.4.2 Angle of Entry

Recently, agencies have evaluated the use of CRT designs with modified geometry intended to improve visibility and reduce speeds [51]. The conventional design with the relatively high angle of entry may be appropriate for situations where either yield or no control is employed and there is not an expectation of pedestrian crossings [15, 25]. However, the modified design with the relatively low angle of entry (**Figure 17**) is preferred when pedestrians are expected to cross the channelized facility [15, 25]. Research conducted by Schattler et al [18] demonstrated that drivers traversing the modified design used fewer exaggerated head turns, executed fewer “roll-and-go” stops, and were less likely to stop past the stop bar. This design was also associated with reduced total and rear end crashes within the subject approach. Ultimately, Schroeder et al [25] provides the guidance that channelized facilities should be designed to encourage lower travel speeds, minimize drivers turning their head to the left to identify gaps, and ensure separation between the space where drivers identify gaps in cross street traffic and yielding to pedestrians. While the impacts to pedestrian safety have not been quantified, this type of geometry presents a promising strategy for improving pedestrian safety. **Figure 18** provides an example where the conventional high angle of entry and modern low angle of entry designs are used at the same intersection.

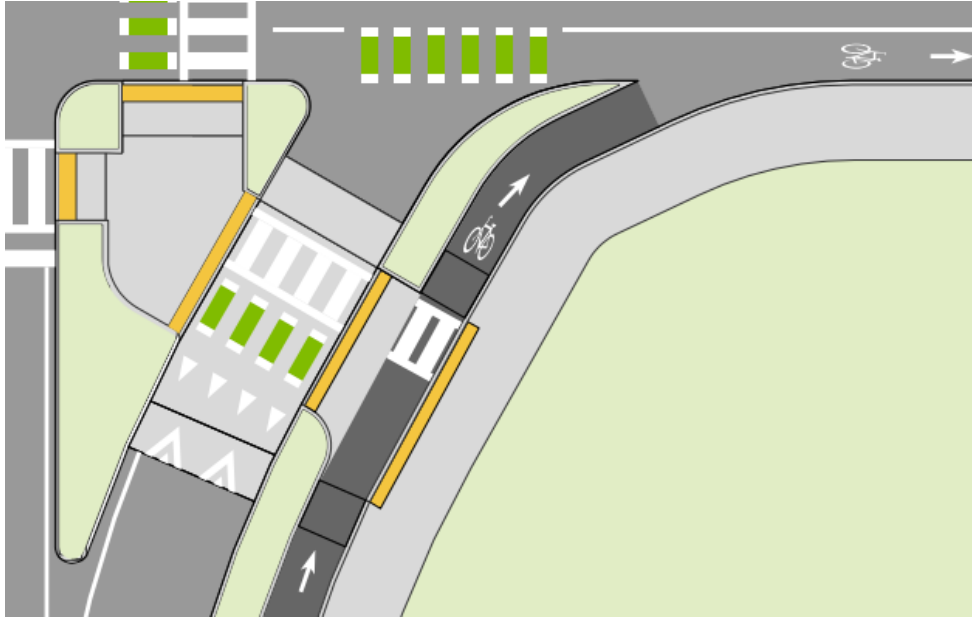

Figure 17. Example of modern low angle of entry CRT design [33].

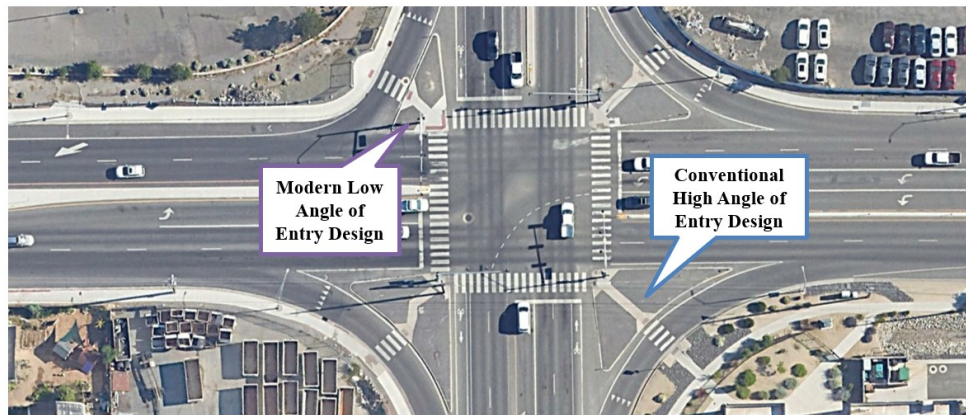

Figure 18. Example of conventional high angle vs. modern low angle of entry island design at CRT [3].

2.2.4.3 Deceleration and Acceleration Lanes

The inclusion of either deceleration or acceleration lanes represents another important design control for CRTs that have the potential to influence driver behavior (**Figure 19**). Deceleration lanes have generally been identified as positive for pedestrians given the potential to reduce vehicle speeds as well as the potential for queues at the entrance to the channelized lane [25]. Schroeder et al [25] also suggested that the presence of a deceleration lane may improve the ability for pedestrians with vision disabilities to detect approaching vehicles. A previous survey of roadway agencies suggested that the majority of both state (89 percent) and local agencies (70 percent) employ deceleration lanes at least some CRTs [1].

Schroeder et al [25] suggested that the use of acceleration lanes should be avoided due to the fact that they are intended to increase speeds. This was also consistent with mobility specialists interviewed by Potts et al [15] that indicated that channelized islands with acceleration lanes were difficult to cross. Other work [1] has suggested that acceleration lanes may improve safety performance for pedestrians as they may allow drivers to focus on the crosswalk as opposed to identifying gaps in cross street traffic to complete a downstream merge. A previous survey of roadway agencies suggested that the majority of state agencies (77 percent) employ acceleration lanes at least some CRT locations, while their use was less frequent among local agencies (43 percent) [1].



Figure 19. Examples of deceleration and acceleration lanes at CRTs [3].

Chapter 3: Current Practice in the United States

To provide additional context beyond the current body of research summarized in **Chapter 2**, a review of current practices for CRT design and implementation in urban and suburban areas in the United States was performed. This review of current nationwide CRT practices was performed by conducting an online survey of state and local roadway agencies across the U.S. (**Section 3.1**), in addition to a detailed review of existing state DOT policies and guidance (**Section 3.2**).

3.1 Survey of State and Local Agencies

A survey of state and local roadway agencies was developed based on the findings of the literature review summarized in **Chapter 2**. This roadway agency survey was intended to identify best practices for the deployment of CRTs at signalized intersections in urban or suburban environments in a manner that provides safety and accessibility for all road users. The survey included questions related to the type of traffic control used at CRTs, crosswalk surface treatments, crosswalk placement, crossing signs and beacons, traffic signals, geometric design, and other strategies specific to pedestrians with vision impairments or other disabilities. The survey was developed in Qualtrics and subsequently emailed to staff at state and local agencies across the United States. A copy of the Qualtrics survey form is included in **Appendix A**.

Given the fact that the survey included design and planning questions that cut across a number of areas, ranging from traffic and geometric design to pedestrian- and bicycle-specific considerations, the survey was distributed to targeted staff across a variety of positions at each state DOT. This included each state's bicycle and pedestrian coordinator [52] as well as statewide traffic and safety personnel. A number of state agencies coordinated their response at the statewide level, while others provided multiple responses at the regional level depending on the state's management of CRTs.

Local roadway agencies outside of Minnesota were contacted by identifying relevant traffic and safety engineering staff, vision zero coordinators, or pedestrian- and bicycle-focused personnel. This included staff at regional metropolitan planning organizations (MPOs), county roadway agencies, and medium to large city agencies.

Ultimately, 49 total responses were obtained representing 30 state DOTs and 9 local roadway agencies outside of Minnesota (**Figure 20**). The following subsections (**Sections 3.1.1 to 3.1.9**) provide a summary of the key findings obtained from both state and local roadway agencies, including detailed commentary for specific concepts.

Finally, it should be noted that the agency survey was also provided to local roadway agencies within Minnesota as a part of a distinct process to identify current practices within the state. These findings specific to Minnesota local agencies can be found in **Section 4.2**.

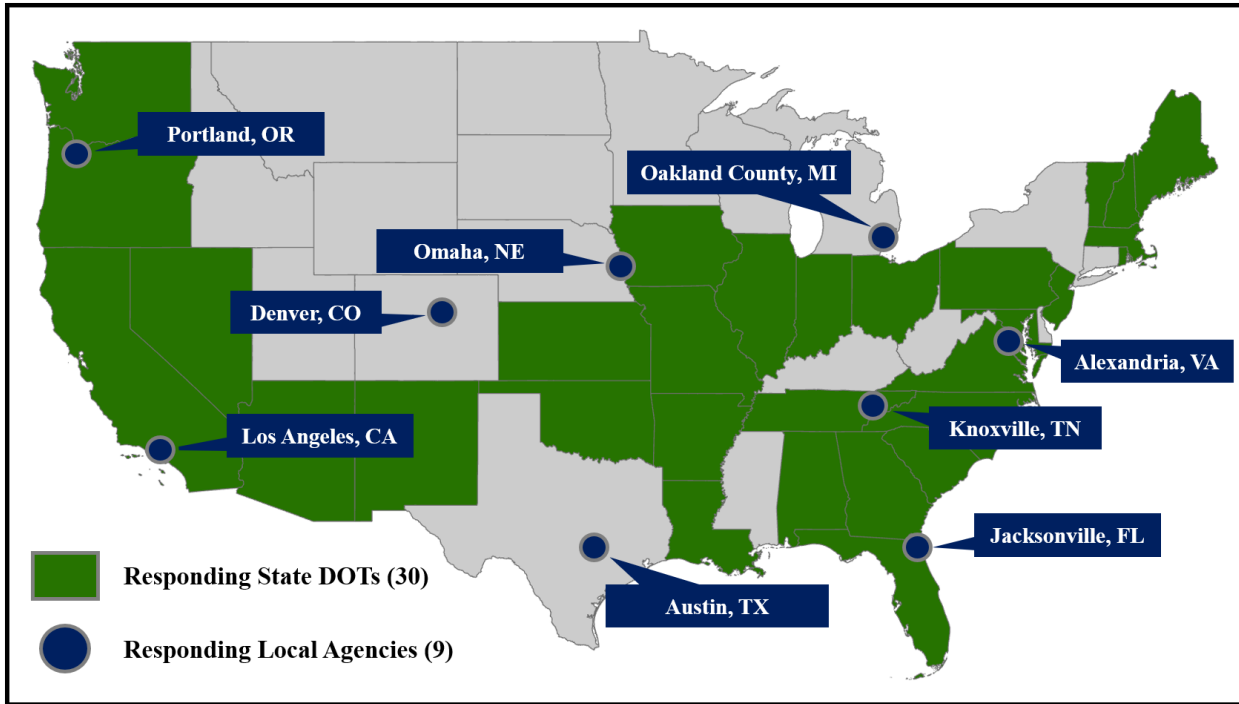

Figure 20. Map of responding state and local agencies.

3.1.1 Agency Use of CRTs

Participants were initially asked if CRTs are used at signalized intersections in urbanized areas within their jurisdiction where pedestrians are expected to cross. The responses to this question are summarized in **Table 3**.

Table 3. Use of CRTs at Signalized Intersections where Pedestrians are Expected to Cross (N = 49)

Use Channelized Right Turns	State DOTs		Local Agencies	
	Count	Percentage	Count	Percentage
Yes	35	90%	9	90%
No	3	8%	1	10%
Unsure	1	3%	0	0%
Total	39	100%	10	100%

While the overwhelming majority of state (90 percent) and local (90 percent) agency staff indicated CRTs have been used at signalized intersections where pedestrians are expected to cross, it should be noted that a number of these agencies also commented that they were currently reviewing both the appropriate context for these facilities and potential mitigation strategies to improve safety. In other words, CRTs have represented a common design option across the United States in urban and suburban environments but many agencies are in the process of reevaluating the appropriate use of these facilities. When CRT designs are used, many agencies are incorporating mitigation strategies to enhance the crossing for non-motorized users. This includes consideration of treatments to satisfy the revised PROWAG requirements for multilane channelized facilities [48].

3.1.2 Traffic Control Type

Participants were asked to indicate the types of traffic control used within the CRT lane at signalized intersections within their jurisdiction where pedestrians are expected to cross, with the results presented in **Table 4**. Note that the question was not intended to be specific to traffic control used at the crosswalk within the CRT.

Table 4. Type of Traffic Control Used within the CRT Lane by Agency Type

State DOT Responses (N = 35)					
Control Type	Never	Rarely	Sometimes	Frequently	Unsure
No Control	31.4%	22.9%	25.7%	14.3%	5.7%
Yield Control	0.0%	22.9%	17.1%	60.0%	0.0%
Stop Control	11.4%	54.3%	25.7%	2.9%	5.7%
Signal Control	0.0%	28.6%	42.9%	25.7%	2.9%
Local Agency Responses (N = 9)					
Control Type	Never	Rarely	Sometimes	Frequently	Unsure
No Control	11.1%	33.3%	11.1%	44.4%	0.0%
Yield Control	0.0%	11.1%	22.2%	66.7%	0.0%
Stop Control	0.0%	44.4%	55.6%	0.0%	0.0%
Signal Control	0.0%	33.3%	66.7%	0.0%	0.0%

Yield control represents the predominate type of traffic control used at CRTs in these environments, where 60.0 percent of state DOT staff and 66.7 percent of local agency staff identified that they frequently use yield control in these scenarios. Stop control represents an option that roadway agencies will consider for specific scenarios but are generally not the first option. Signal control is also used less frequently than yield control but remains an option that agencies will consider, particularly at locations that require multiple lanes to service relatively high turning volumes. It should be noted that signal control satisfies the revised PROWAG requirements for multilane channelized facilities [48]. While a number of state DOTs avoid the use of uncontrolled channelized right-turn movements in these scenarios (31.4 percent), it should be noted that 62.9 percent of state DOT staff and 88.9 percent of local agency staff indicated that uncontrolled channelized right turns are employed within their jurisdiction to some level. Detailed comments from agencies related to traffic control specific to the CRTs include:

- The New Jersey DOT identifies traffic volumes as the primary characteristic used to determine first if either static (i.e. yield control or stop control) or signal control is used for the CRT movement.
- The New Hampshire DOT noted that the agency will typically not use signal control at CRTs unless there are site-specific concerns (such as sight distance).

- The Massachusetts DOT noted that the state access board requires that all channelized right-turn lanes be signalized.

3.1.3 Crosswalk Surface Treatments

Participants were asked to indicate the frequency of use among crosswalk surface treatments (as discussed in **Section 2.2.1**) for CRTs within their jurisdiction at signalized intersections in urban areas where pedestrians are expected to cross (**Table 5**).

Table 5. Crosswalk Surface Treatments for CRTs by Agency Type

State DOT Responses (N = 35)					
Surface Treatment	Never	Rarely	Sometimes	Frequently	Unsure
High-Visibility Crosswalk Markings	2.9%	2.9%	22.9%	71.4%	0.0%
Raised Crosswalks	62.9%	34.3%	0.0%	0.0%	2.9%
Advance Yield Markings	17.1%	25.7%	42.9%	11.4%	2.9%
Texturing Crosswalks	25.7%	57.1%	11.4%	0.0%	5.7%
Local Agency Responses (N = 9)					
Surface Treatment	Never	Rarely	Sometimes	Frequently	Unsure
High-Visibility Crosswalk Markings	0.0%	0.0%	22.2%	77.8%	0.0%
Raised Crosswalks	55.6%	33.3%	0.0%	11.1%	0.0%
Advance Yield Markings	11.1%	0.0%	55.6%	33.3%	0.0%
Texturing Crosswalks	33.3%	44.4%	22.2%	0.0%	0.0%

High-visibility crosswalk markings represent a treatment that is becoming increasingly common at these facilities, where 71.4 percent of state DOT staff and 77.8 percent of local agency staff indicated that they are frequently used within their jurisdiction. While raised crosswalk use has been less common, a number of agencies indicated that they have recently employed this strategy and are seeking to expand its use. Advanced yield markings are often used consistent with the finding from **Table 4** that yield control represents the most common type of traffic control. Detailed comments from agencies related to crosswalk surface treatments include:

- The Indiana DOT noted that the agency will use in-laid paver blocks or bricks as a textured crossing surface for CRTs. However, a number of agencies did indicate that they do not permit the use of textured crosswalk surfaces.
- The Maine DOT noted that typically high-visibility crosswalk markings are used in designs, but the agency is increasingly interested in expanding into the use of raised crosswalks or other surface materials beyond conventional pavement markings.
- The New Hampshire DOT noted that the department uses high visibility crosswalk markings in scenarios where the crosswalk is located upstream of the yield or stop line.
- The City of Jacksonville is seeking to expand the use of raised crosswalks at CRTs.
- The City of Austin has made a raised crossing the standard design at CRTs.

- The City of Los Angeles noted that they have used raised pavement markers as a part of CRT designs. High-visibility crosswalk markings and advance yield pavement markings are also the standard in the city.

3.1.4 Crosswalk Placement

Participants were asked to indicate the frequency of use among crosswalk placement strategies (as discussed in **Section 2.2.2**) for CRTs within their jurisdiction at signalized intersections in urbanized areas where pedestrians are expected to cross (**Table 6**).

Table 6. Crosswalk Placement at CRTs by Agency Type

State DOT Responses (N = 35)					
Placement	Never	Rarely	Sometimes	Frequently	Unsure
Upstream - Parallel	48.6%	34.3%	8.6%	0.0%	8.6%
Upstream - Perpendicular	14.3%	54.3%	17.1%	8.6%	5.7%
Center - Perpendicular	5.7%	5.7%	25.7%	60.0%	2.9%
Downstream - Parallel	34.3%	28.6%	22.9%	2.9%	11.4%
Downstream - Perpendicular	22.9%	37.1%	28.6%	8.6%	2.9%
Local Agency Responses (N = 9)					
Placement	Never	Rarely	Sometimes	Frequently	Unsure
Upstream - Parallel	33.3%	44.4%	11.1%	0.0%	11.1%
Upstream - Perpendicular	0.0%	44.4%	44.4%	11.1%	0.0%
Center - Perpendicular	0.0%	0.0%	33.3%	66.7%	0.0%
Downstream - Parallel	33.3%	44.4%	11.1%	0.0%	11.1%
Downstream - Perpendicular	11.1%	11.1%	44.4%	33.3%	0.0%

The center–perpendicular crosswalk placement represents the most common approach employed by both state and local roadway agencies. Upstream and downstream placements are used depending on site specific conditions or agency-specific guidance. Detailed comments from agencies related to crosswalk placement include:

- The Maine DOT, Nevada DOT, and North Carolina DOT noted that crosswalk placement is often determined based on the specific site characteristics.
- The Nevada DOT expressed a preference for upstream placements to provide an opportunity for approaching drivers to see pedestrians in a position to cross.
- The New Jersey DOT expressed a preference for perpendicular designs in order to minimize crossing distance. Additionally, the state prefers either upstream (to improve visibility) or downstream placements (where speeds may be lower with more time to stop) as opposed to the center placement.

- The Louisiana DOTD prefers the perpendicular design as there is a perception that this increases driver awareness of the crossing.
- The Massachusetts DOT notes that downstream placement is common in the state due to the requirement that all channelized right-turn lanes be signal controlled and therefore the crosswalk is generally placed downstream of the stop bar.

3.1.5 Crosswalk Signing and Beacon Treatments

Participants were asked to indicate the frequency of use among several crosswalk sign and beacon strategies (as discussed in **Section 2.2.3**) for CRTs within their jurisdiction at signalized intersections in urbanized areas where pedestrians are expected to cross (**Table 7**).

Table 7. Crosswalk Signs and Beacons Used at CRTs by Agency Type

State DOT Responses (N = 35)					
Treatment	Never	Rarely	Sometimes	Frequently	Unsure
R1-5 Signs	17.1%	20.0%	40.0%	20.0%	2.9%
In-Street R1-6 Signs	45.7%	40.0%	11.4%	2.9%	0.0%
Curbside R1-6 Signs	28.6%	42.9%	17.1%	11.4%	0.0%
W11-2 Signs	2.9%	5.7%	22.9%	68.6%	0.0%
Overhead Amber Beacons	51.4%	31.4%	14.3%	0.0%	2.9%
Sign-Mounted Amber Beacons	34.3%	37.1%	20.0%	5.7%	2.9%
RRFBs	20.0%	34.3%	40.0%	5.7%	0.0%
PHBs	51.4%	31.4%	17.1%	0.0%	0.0%
Local Agency Responses (N = 9)					
Treatment	Never	Rarely	Sometimes	Frequently	Unsure
R1-5 Signs	11.1%	11.1%	44.4%	22.2%	11.1%
In-Street R1-6 Signs	44.4%	33.3%	22.2%	0.0%	0.0%
Curbside R1-6 Signs	33.3%	33.3%	22.2%	11.1%	0.0%
W11-2 Signs	0.0%	11.1%	22.2%	66.7%	0.0%
Overhead Amber Beacons	77.8%	11.1%	0.0%	0.0%	11.1%
Sign-Mounted Amber Beacons	55.6%	11.1%	33.3%	0.0%	0.0%
RRFBs	22.2%	11.1%	22.2%	44.4%	0.0%
PHBs	55.6%	11.1%	11.1%	22.2%	0.0%

W11-2 signs represent the most common signing enhancement, where 68.6 percent of state DOT staff and 66.7 percent of local agency staff indicated they were used frequently. R1-5 series signs are also another common inclusion depending on the type of traffic control used and state law. RRFBs have been used more frequently than overhead or sign-mounted beacons and several agencies indicated that they are in the process of expanding the use of PHBs. Detailed comments include:

- The Ohio DOT noted that there are a number of intersections with CRTs that are currently in the design phase to add PHBs in the future.
- The New Jersey DOT identified the use of R10-15 signs as a part of their traffic control strategy, particularly where RTOR is permitted. The Oregon DOT and Indiana DOT also noted that they will employ R10-15 signs at CRTs.

- The New Hampshire DOT noted that the department uses warning signs in scenarios where the crosswalk is located upstream of the yield or stop line. RRFBs may be used in scenarios where right-turn volumes are relatively high (or greater than 7,000 vehicles per day) and would typically be maintained by the municipality.
- The Nevada DOT noted that the department is seeking to expand the use of PHBs.
- The Denver Council of Governments noted that local agencies in the Denver area tend to employ R1-5 signs as anecdotal experience has suggested these are well understood by drivers.

3.1.6 Traffic Signal Strategies

Participants were asked to indicate the frequency of use among several traffic signal strategies (as discussed in **Section 2.2.3**) for CRTs within their jurisdiction at signalized intersections in urbanized areas where pedestrians are expected to cross (**Table 8**).

Table 8. Traffic Signal Strategies for CRTs by Agency Type

State DOT Responses (N = 35)					
Treatment	Never	Rarely	Sometimes	Frequently	Unsure
Push Buttons	11.4%	34.3%	31.4%	22.9%	0.0%
Accessible Pedestrian Signals	0.0%	17.1%	37.1%	37.1%	8.6%
Leading Pedestrian Intervals	25.7%	25.7%	40.0%	2.9%	5.7%
Static RTOR Restrictions	11.4%	28.6%	45.7%	11.4%	2.9%
Dynamic RTOR Restrictions	34.3%	51.4%	5.7%	0.0%	8.6%
Green Ball Signal Indications	8.6%	37.1%	31.4%	17.1%	5.7%
Green Arrow Signal Indications	8.6%	34.3%	34.3%	20.0%	2.9%
Flashing Yellow Arrow Signal Indications	57.1%	22.9%	5.7%	11.4%	2.9%
Roadside Mounted Signals	31.4%	28.6%	25.7%	11.4%	2.9%
Overhead Signals	8.6%	28.6%	31.4%	28.6%	2.9%
Overhead and Roadside Signals	14.3%	37.1%	34.3%	8.6%	5.7%
Local Agency Responses (N = 9)					
Treatment	Never	Rarely	Sometimes	Frequently	Unsure
Push Buttons	11.1%	22.2%	44.4%	11.1%	11.1%
Accessible Pedestrian Signals	0.0%	11.1%	55.6%	33.3%	0.0%
Leading Pedestrian Intervals	33.3%	22.2%	22.2%	22.2%	0.0%
Static RTOR Restrictions	33.3%	22.2%	33.3%	11.1%	0.0%
Dynamic RTOR Restrictions	33.3%	55.6%	11.1%	0.0%	0.0%
Green Ball Signal Indications	11.1%	44.4%	33.3%	0.0%	11.1%
Green Arrow Signal Indications	0.0%	33.3%	55.6%	0.0%	11.1%
Flashing Yellow Arrow Signal Indications	33.3%	44.4%	22.2%	0.0%	0.0%
Roadside Mounted Signals	22.2%	0.0%	22.2%	11.1%	44.4%
Overhead Signals	0.0%	33.3%	44.4%	0.0%	22.2%
Overhead and Roadside Signals	11.1%	44.4%	11.1%	0.0%	33.3%

Push buttons and accessible pedestrian signal technology represent treatments are commonly included in these scenarios and are often dictated by state law or agency policies. While many agencies have never used LPs with CRTs, they have been used as a potential option to consider depending on site conditions. Similarly, many agencies have never used either static or dynamic RTOR restrictions, but they represent a potential option to consider depending on site conditions. Intuitively, static RTOR restrictions appear to be more common than dynamic RTOR restrictions. Agencies have used a broad range of traffic signal head configurations, with flashing yellow arrows tending to be the least commonly

used option. The use of green ball and green arrow indications was nearly identical among state DOTs. Signals placed overhead tended to be the most common approach among state DOTs. Detailed comments from agencies related to traffic signals include:

- The Washington DOT notes that if the right-turn channel itself is signalized, the department will always include APS technology. The Washington DOT also noted that many jurisdictions in the state incorporate systemic LPIs and therefore intersections within those jurisdictions that include right-turn channelization would also include LPIs.
- The Oklahoma DOT prefers a flashing red indication when RTOR is permitted at CRTs.

3.1.7 Geometric Design Strategies

Participants were asked to indicate the frequency of use among several geometric design strategies (as discussed in **Section 2.2.4**) for CRTs within their jurisdiction at signalized intersections in urban areas where pedestrians are expected to cross (**Table 9**).

Table 9. Geometric Design Strategies for CRTs by Agency Type

State DOT Responses (N = 35)					
Treatment	Never	Rarely	Sometimes	Frequently	Unsure
Deceleration Lane	0.0%	2.9%	31.4%	65.7%	0.0%
Acceleration Lane	0.0%	25.7%	54.3%	17.1%	2.9%
Cut Through Island	0.0%	11.4%	45.7%	40.0%	2.9%
Ramped Island	0.0%	20.0%	48.6%	28.6%	2.9%
Low Angle of Entry	2.9%	25.7%	48.6%	14.3%	8.6%
High Angle of Entry	0.0%	11.4%	65.7%	14.3%	8.6%
Lane Narrowing	20.0%	51.4%	20.0%	2.9%	5.7%
Local Agency Responses (N = 9)					
Treatment	Never	Rarely	Sometimes	Frequently	Unsure
Deceleration Lane	11.1%	22.2%	44.4%	22.2%	0.0%
Acceleration Lane	0.0%	33.3%	66.7%	0.0%	0.0%
Cut Through Island	0.0%	11.1%	44.4%	44.4%	0.0%
Ramped Island	11.1%	11.1%	44.4%	33.3%	0.0%
Low Angle of Entry	11.1%	22.2%	33.3%	22.2%	11.1%
High Angle of Entry	0.0%	11.1%	66.7%	11.1%	11.1%
Lane Narrowing	22.2%	22.2%	33.3%	22.2%	0.0%

Deceleration lanes are often included at these facilities and the use of acceleration lanes was less common consistent with the literature review (**Section 2.2.4**). Both the ramped and cut through approaches to accommodating pedestrian pathing at channelized islands are commonly used by state DOTs and local agencies. A common theme noted by several state DOTs is that while conventional high angle of entry designs remain in place across the United States, agencies are working to increase the use of the modern low angle of entry geometric design. This includes both retrofitting existing locations or employing the modern design for new facilities. Detailed comments related to geometric design include:

- The Washington DOT identified lane narrowing as a potential option being investigated by the agency to improve safety, including the use of truck aprons to accommodate vehicles with turning radii requirements.
- The New Jersey DOT noted that both cut through and ramped approaches to island design are used depending on the space available at the specific location. The department also noted that lane narrowing is generally avoided due to snow removal considerations.
- The City of Austin has made the modern low angle of entry design the standard.

3.1.8 Other Comments from State and Local Agencies

In addition to the detailed comments provided by roadway agencies specific to each topic summarized in **Sections 3.1.1 to 3.1.7**, state and local agencies also provided a number of general comments related to CRTs at signalized intersections where pedestrians are expected to cross. These comments are summarized in **Table 10**.

Table 10. Summary of Other Comments from State and Local Agencies

Agency	Comment
City of Alexandria, VA	The city is systemically attempting to remove existing CRTs due to pedestrian safety concerns. In the interim period before removal, common treatments (such as high-visibility crosswalk markings, advance yield markings, RRFBs or RTOR restrictions) are employed to improve safety. The city has also experienced situations where bicycle lanes that were carried through channelized facilities encountered encroachments by vehicles into the designated bicycle space (and agency is currently evaluating alternative design options to address this concern).
Denver Regional Council of Governments	Local agencies in the Denver region have generally been moving away from the use of CRT designs where pedestrian and bicyclists are expected to cross. In scenarios where CRTs are used, green bicycle pavement markings, raised crossings, and advance yield markings have been implemented.
Kansas	The state does maintain a number of free-flowing CRTs but in general this design is avoided due to pedestrian safety concerns.
City of Los Angeles, CA	The city is currently developing a strategy to systematically remove all CRTs.
Maine	The state has generally been either removing or reducing the radius of existing intersections with CRTs. However, there remains a number of locations across the state that still include CRTs that allow high speed right turns.
Nevada	The department noted pedestrian-focused lighting and the minimization of fixed objects that can impede sight distance as potential design considerations.
City of Portland, OR	The city is systemically attempting to remove existing CRTs due to pedestrian safety concerns. In scenarios where the channel cannot be removed, the city is removing associated deceleration lanes.

3.1.9 Examples of Innovative CRT Designs

Survey participants were also requested to identify any CRT locations with innovative or successful treatments within their jurisdiction. Examples obtained from the survey are included below, including satellite and/or street view imagery that highlight specific elements of the design.

The City of Austin identified the CRT at Lamar Boulevard and W 29th Street (**Figure 21**) as an example of a design that has been recognized within the community as a success for pedestrians with vision disabilities as well as users of the trail that crosses the signalized intersection. The design includes a raised crossing with a mountable truck apron that allows for minimizing the radius (while still accommodating larger vehicles).



Figure 21. Lamar Boulevard at W 29th Street in Austin, Texas [3].

The Denver Regional Council of Governments also identified the CO-470 exit ramp to W Ken Caryl Avenue (**Figure 22**) as an effective design that incorporates a raised crossing and a RRFB to accommodate a trail crossing through the interchange.





Figure 22. CO-470 Exit Ramp to W Ken Caryl Avenue in Littleton, Colorado [3].

The Denver Regional Council of Governments also noted unique CRT at Arapahoe Street and Speer Boulevard in Denver (Figure 23) due to the inclusion of the vertical delineation devices and lane narrowing incorporated within the design.



Figure 23. Arapahoe Street and Speer Boulevard in Denver, Colorado [3].

The Oklahoma DOT identified the CRT designs integrated at the diverging diamond interchange of I-20 and Main Street in Elk City (Figure 24). This includes cut through channelizing islands, RRFBs, and advanced yield line pavement markings.



Figure 24. I-20 Exit Ramp at Main Street in Elk City, Oklahoma [3].

The Oregon DOT notes that there are select locations in the state where a bicycle signal head has been incorporated at CRTs in order to accommodate a bicycle lane running along the cross street, such as the example at the intersection of OR-18 and Pacific Highway in Dundee, OR (Figure 25).



Figure 25. OR-18 at Pacific Highway in Dundee, Oregon [3].

The Oregon DOT has also extended green intersection pavement markings for bicycle lanes across CRTs, such as the Edgewater Street entrance ramp to OR-22 located in Salem (Figure 26).



Figure 26. Edgewater Street Entrance Ramp to OR-22 in Salem, Oregon [3].

The Oregon DOT also noted the design employed at US-20 and Butler Market Road in the City of Bend where a raised crossing was implemented at a CRT with yield control (Figure 27).



Figure 27. US-20 at Butler Market Road in Bend, Oregon [3].

The Washington DOT identified the I-5 exit ramp at Mill Plain Boulevard in Vancouver (Figure 28) as an example of a unique design that includes both an RRFB as well as incorporation of the bicycle lane with the crosswalk. The Washington DOT also identified a unique design located in Seattle (Figure 29) that incorporates an extended channel, advanced yield markings, and a bicycle lane.



Figure 28. I-5 Exit Ramp at Mill Plain Boulevard in Vancouver, Washington [3].



Figure 29. Fremont Avenue at 34th Street in Seattle, Washington [3].

3.2 Summary of State DOT Policy and Guidance Related to CRTs

In addition to the nationwide survey of roadway agencies, a detailed review of state DOT policies and guidance related to CRTs was conducted. While this review sought to identify general information related to CRT use, a specific emphasis was placed on design features intended for CRTs used at signalized intersections in urban or suburban environments where pedestrians are expected to cross. Materials were identified via a web search of the publicly available documentation published by each state agency as well as documentation that was obtained as a part of the agency survey (summarized in **Section 3.1**).

Policies and guidance specific to CRTs were identified for 32 state DOTs. It should be noted that this only included cases where tangible planning and design guidance was provided (i.e. specific dimensions, design criteria, or other engineering-level information) beyond a simple overview of CRTs as a potential design alternative. While complete details (including a link to the relevant documents) for each state are provided in **Table 11**, several general findings include:

- Fourteen state DOTs specifically identify or discuss the modern low angle of entry geometric design as a preferred alternative for scenarios where pedestrians are expected to cross.

- Six state DOTs identify high visibility crosswalk markings as the standard crosswalk treatment either within written guidance or within standard plans.
- Six state DOTs identify the center – perpendicular crosswalk placement as the default design either within written guidance or within standard plans. Additionally, two states identified a perpendicular crosswalk placement as the default within written guidance.
- Six state DOTs identified yield control as the default traffic control option for CRTs.

Table 11. Summary of State DOT Policies and Guidance for CRTs

State	Summary
Alabama	Alabama maintains two standard plans for CRTs in urban areas, including one with and without a deceleration lane. Details are also included to incorporate a bicycle lane. A minimum radius of 280 feet is specified. The minimum area for the channelizing island is specified at 100 square feet. The width of the channel is specified at 16 feet. The crosswalk is typically placed 20 feet upstream of the cross street. While a single yield sign on the right side of the channel is included, the plans allow for a secondary optional yield sign placed on the left of the channel.
Arizona	Arizona DOT's Roadway Design Guidelines provide general guidance for the use of CRTs, including the consideration of non-motorized road users. Arizona's guidance allows for the use of "free right turns" that are uncontrolled and must include an acceleration lane.
California	The Caltrans Highway Design Manual expresses a preference for channelization to address concerns related to complex multilane undivided intersections. The document also provides general guidance for the use of right-turn channelization, including the consideration of non-motorized road users. In cases where traffic is uncontrolled, the curve radius should be designed to ensure that operating speeds are less than 20 miles per hour. Channelizing islands should not be less than 50 square feet in area, with a recommended minimum of at least 75 square feet.
Colorado	The Roadway Design Guide provides general guidance for the use of CRTs, including the consideration of non-motorized road users. The guidance identifies that channelized designs can improve safety for all road users with appropriate design features and can be considered at locations with relatively high right-turn volumes. Channelizing islands should be designed such that they are large enough to demand attention, with a preferred area of at least 100 feet (with a minimum of 50 feet in urban areas). Single lane facilities should be yield controlled with yield lines placed at least four feet in front of the crosswalk. Raised crossings can be considered when there are yielding concerns at specific sites. W11-2 signs should be included at the approach end of the channelizing island to improve visibility. Intersection lighting should generally be included at locations with CRTs. The document also refers to NCHRP Report 279 and NCHRP Research Report 834 for more information.
Connecticut	The Highway Design Manual provides general guidance for the use of CRTs, including the consideration of non-motorized road users. Designs should include raised islands with intersection lighting when pedestrians are present. Channelizing islands should be at least 50 square feet in area, with 100 square feet as a recommended minimum.
Delaware	The Road Design Manual and Development Coordination Manual provides general guidance for the use of CRTs, including the consideration of non-motorized road users. Design controls for CRTs typically include the design vehicle, cross section, drainage, traffic volumes, pedestrian and bicycle facilities, operating speeds, and traffic control devices. Channelizing islands should be at least 50 square feet in area, with 100 square feet as a recommended minimum.

State	Summary
Florida	The FDOT Design Manual provides general guidance for the use of CRTs, including the consideration of non-motorized road users. Designs should include raised islands with intersection lighting when pedestrians are present. Channelizing islands should be at least 50 square feet in area, with 100 square feet as a recommended minimum. The modern low angle of entry design with a deceleration lane and without an acceleration lane is preferred where pedestrians are expected to cross. The crosswalk should be set back a minimum of 20 feet from the cross street to allow vehicles to wait for gaps without blocking the crosswalk. The manual also includes details to integrate green bicycle pavement markings at CRTs.
Georgia	Guidance for CRTs is provided in the Traffic Signal Design Guidelines and the Pedestrian and Streetscape Guide . Both the use of curb ramps and cut through approaches to the pedestrian pathway at channelizing island are noted in the guidance. The modern low angle of entry approach is recommended where pedestrians are present. STATE LAW STOP FOR PEDESTRIANS IN CROSSWALK signs are standard for uncontrolled designs. The <i>Pedestrian and Streetscape Guide</i> notes that channelized designs are not preferred for intersections in urban core, urban, or rural town areas where there may be high pedestrian volumes or a significant population of disabled road users. High-visibility crosswalk markings are also preferred for this design. Channelizing islands should be at least 50 square feet in area, with 100 square feet as a recommended minimum.
Hawaii	The Pedestrian Toolbox provides general guidance for the use of CRTs, including the consideration of non-motorized road users. The use of CRTs is discouraged due to concerns related to pedestrian safety, but the document notes that when used these facilities can be designed to mitigate those concerns. The guidance identifies raised pedestrian crossings as a standard for CRTs. Pavement width of the channel should be a maximum of 16 feet unless design vehicles dictate more space. The guidance recommends the use of R10-15 or W11-2 signs to enhance crossing safety for yield controlled designs. However, signalization should be included at locations with relatively high turn volumes to ensure opportunities to complete crossing movements. The document also notes that CRTs lanes may be beneficial for pedestrians when relatively large turning radii (over 50 feet) are required to accommodate the design vehicle.
Illinois	The Bureau of Design and Environment Manual provides general guidance for the use of CRTs, including the consideration of non-motorized road users. The guidance identifies the modern low angle of entry design as the standard for the state and discusses the potential safety benefits of this approach. The guidance notes that existing locations with the conventional high angle of entry design should be considered for potential retrofits. Channelizing islands should be at least 50 square feet in area, with 75 square feet as a recommended minimum. The cut through approach is identified as the standard for pedestrian pathing through the channelizing island. The document includes detailed geometric guidance for a number of design scenarios. Guidelines are also provided for the consideration of both acceleration and deceleration lanes. Warrants are provided to determine when to consider the use of CRTs. The document also refers to NCHRP Report 279 for more information.
Indiana	The Design Manual provides general guidance for the use of CRTs, including the consideration of non-motorized road users. Channelizing islands should be at least 50 square feet in area, with 100 square feet as a recommended minimum (or 160 square feet if it is used as a pedestrian refuge). The guidance notes that each intersection should be evaluated on an individual basis and designs should consider turning volumes, traffic configuration, potential conflicts, and traffic control devices.
Kentucky	The Complete Streets, Roads, and Highways Manual identifies the modern low angle of entry design as the preferred option for CRTs.
Louisiana	While the Road Design Manual provides only a limited overview of the use of channelized turns, the guidance does state a preference for designs with a low angle of entry.

State	Summary
Mississippi	The Road Design Manual provides general guidance for the use of CRTs, including the consideration of non-motorized road users. Channelizing islands in urban areas should not be less than 12 feet on each side as a minimum, with a recommended minimum of 15 feet.
Montana	The Road Design Manual provides general guidance for the use of CRTs, including the consideration of non-motorized road users. The guidance notes that channelized designs may have a role in specific circumstances to provide refuge for pedestrians across multilane facilities when traffic volumes are relatively high. Crossing islands should be at least six feet wide. The document also identifies the modern low angle of entry design as a potential option to consider that is more desirable for pedestrians.
Nebraska	The Road Design Manual provides general guidance for the use of CRTs, including the consideration of non-motorized road users. The guidance notes that drivers should be presented with no more than one decision at any time and lighting should be included where a raised island is employed.
New Hampshire	The Highway Design Manual provides general guidance for the use of CRTs, including the consideration of non-motorized road users. The guidance notes that there is no standard treatment for the use of CRT designs and each location requires the use of appropriate engineering judgement. Channelizing islands should be at least five square meters in area in urban environments, but nine square meters is preferred. Lighting should be considered where raised islands are used. Designs should separate conflicts such that drivers and pedestrians are only required to make one decision at a time.
New Jersey	The Roadway Design Manual provides general guidance for the use of CRTs, including the consideration of non-motorized road users. Channelizing islands should be designed such that they do not interfere with bicycle traffic, including the inclusion of a four-foot offset between the edge of the travel lane and the island in urban areas. Intersections with channelization should include lighting in urban areas.
New Mexico	The department's Design Manual provides guidance for accommodating pedestrians at locations with CRTs. The guidance notes that channelizing islands may be used for pedestrian refuge but can result in higher operating speeds. The turning radius of designs should be minimized in order to reduce operating speeds and crosswalks should be placed at a right angle to the curb face. The document also provides for the use of both cut through and ramped approaches to pedestrian routing through the island.
New York	The Highway Design Manual provides general guidance for the use of CRTs, including the consideration of non-motorized road users. The width of the channelizing island should be at least six feet if it is intended to provide pedestrian refuge. Guidance is provided for accommodating pedestrians with vision disabilities, including the use of accessible signal technology. The document also refers to NCHRP Report 279 for more information.
North Carolina	While the department does maintain a standard plan for the design of channelizing island with a cut through approach to pedestrian routing, the state's Roadway Design Manual refers to the Green Book for more information related to CRT design.
Ohio	The Location & Design Manual and Multimodal Design Guide provide general guidance for the use of CRTs, including the consideration of non-motorized road users. The guidance identifies the modern low angle of entry design as the preferred alternative to accommodate pedestrians and bicyclists. Channelizing islands should be at least 50 square feet in urban areas, with a preferred minimum of 100 square feet. The crosswalk should be located such that there is enough space for at least one vehicle to queue between the cross street and crosswalk. Raised crossings should also be considered where stop or signal control is not employed.
Oregon	The state's Traffic Manual and Highway Design Manual provide general guidance for the use of CRTs, including the consideration of non-motorized road users. The document provides detailed guidance for the selection of traffic control for the channelized movement. The guidance notes that channelized designs can be a detriment to pedestrian safety if they allow for relatively high turning speeds, do not optimize crosswalk sight lines, and do not minimize

State	Summary
	crossing distances. The guidance provides for the use of both cut through and ramp approaches to accommodating pedestrian pathing through the channelizing island. Crosswalks should be perpendicular to the turn lane and be positioned one car length back from the intersecting roadway. The modern low angle of entry design should be used and the guidance also notes that high-visibility crosswalk markings can enhance safety. The needs of pedestrians with vision impairments should be considered in the design. The document refers to NCHRP Report 674 for more information.
Pennsylvania	The state's standards include a center-perpendicular placement of the crosswalk with standard pavement markings.
South Carolina	The Roadway Design Manual provides general guidance for the use of CRTs, including the consideration of non-motorized road users. Channelizing islands should be large enough to meet the storage needs of pedestrians and bicyclists (or at least 150 square feet if used for refuge) as well as include appropriate design features for accessibility. The need for roadway lighting is determined on a case-by-case basis.
South Dakota	The Roadway Design Manual provides general guidance for the use of CRTs, including the consideration of non-motorized road users. The guidance notes that while appropriate channelized designs can improve safety performance, over-channelization can create potential confusion. Additionally, the guidance notes that providing pedestrian refuge can be a warrant for considering the use of CRTs. The minimum size of channelizing islands is 50 square feet but 100 square feet is preferred.
Tennessee	The Road Design Guidelines and Multimodal Project Scoping Manual provide general guidance for the use of CRTs, including the consideration of non-motorized road users. The guidance notes channelized designs can reduce crossing distances and separate right turn pedestrian-vehicle conflicts. Crosswalks should be placed at least one car length back from the cross street to allow vehicles to complete interactions with crossing pedestrians before focusing on identifying safe gaps in cross street traffic. The guidance identifies both ramped and cut-through approaches to accommodating pedestrian routing, including a minimum of at least five feet in width to ensure there is room for two wheelchair users to pass. Unless required to accommodate design vehicles, pavement widths should be less than 16 feet and the width of the travel lane should be 12 feet or less. The modern low angle of entry design is identified as the preferred alternative for CRTs. Signalization of the right-turn lane can be considered to reduce conflicts when there are multiple lanes, a history of vehicle-pedestrian crashes, or other concerns related to speed or sight distance.
Texas	The Roadway Design Manual provides general guidance for the use of CRTs, including the consideration of non-motorized road users. Raised crosswalks are identified as a potential treatment for CRTs in urban areas where stop or yield control is used. The minimum size of channelizing islands in urban areas is 50 square feet but 100 square feet is preferred. The guidance provides for both cut through and ramped approaches to accommodating pedestrian pathways. The inclusion of deceleration lanes are recommended to reduce operating speeds and help pedestrians identify vehicles making right-turn movements. Acceleration lanes are typically not recommended at locations where pedestrians are expected to cross. Intersections with right-turn channelization should include lighting. Crosswalks should generally be placed in the center of the channel with at least 20 feet between the yield line and the crosswalk. However, crosswalks may be placed at the beginning of the channel in specific design scenarios. Crosswalks placed near the end of the channel are not recommended due to potential conflicts between drivers identifying gaps in cross street traffic and crossing pedestrians. Crosswalks should generally be placed perpendicular to the channel. High-visibility crosswalk markings are recommended. Yield control is typically used in urban areas, with W11-2 warning signs with W16-7PL plaques. The modern low angle of entry design is the preferred alternative for urban and suburban areas. The document also provides guidance for retrofitting CRTs to improve

State	Summary
	safety performance, including the removal of channelization if safety concerns cannot be mitigated with treatments.
Vermont	The Roadway Design Manual provides general guidance for the use of CRTs, including the consideration of non-motorized road users. The guidance notes that while appropriate channelized designs can improve safety performance, over-channelization can create potential confusion.
Washington	The Design Manual provides general guidance for the use of CRTs, including the consideration of non-motorized road users. Channelizing islands in urban areas should be at least 200 square feet if pedestrians are expected to use the facility, including a six foot minimum length in the direction of travel. Crosswalks alignment should be perpendicular to the curb line. The guidance provides for both ramped and cut through approaches to accommodating pedestrian routes, including a passing space of at least five feet to accommodate wheelchairs. The guidance notes that designing intersections without CRTs, removing existing channelized designs, or enhancements to mitigate potential concerns can improve safety for both pedestrians and bicyclists.
Wisconsin	The Facilities Development Manual provides general guidance for the use of CRTs, including the consideration of non-motorized road users. The guidance identifies the modern low angle of entry design as the preferred alternative for CRTs in urban or suburban areas. The minimum recommended size for channelizing islands is 150 square feet. The Traffic Signal Design Manual provides detailed guidance for selecting traffic control for CRTs at signalized intersections. This includes the general concept to begin with less restrictive control and increase depending on traffic volumes, safety performance, pedestrian crossing volumes, and geometric conditions.
Wyoming	The WYDOT ADA Guidelines for Accessibility provides guidance for accommodating pedestrians with disabilities at CRTs. This includes the use of both ramped and cut through approaches to accommodating pedestrian pathways through the island. At least five feet of width should be provided to allow for wheelchair passing. Crosswalk placements that are farther upstream within the channel are identified as desirable to avoid drivers interacting with the crosswalk while attempting to identify gaps in cross street traffic.

Chapter 4: Current Practice in Minnesota

Current practices regarding the use of CRTs at signalized intersections in Minnesota were assessed to provide additional context for the development of guidance and recommendations. This was completed by conducting a review of MnDOT’s current guidance related to CRTs (**Section 4.1**) as well as obtaining feedback from local roadway agencies within Minnesota through a focus group and online survey (**Section 4.2**).

4.1 MnDOT’s Current Guidance Related to CRTs

MnDOT’s existing guidance related to CRTs is primarily contained within four distinct documents, which are summarized in **Table 12**.

Table 12. Summary of MnDOT’s Current Guidance Related to CRTs

Document	Summary
Bicycle Facility Design Manual [53]	This manual identifies the modern low angle of entry design as the preferred alternative anywhere that pedestrians or bicycles are expected. Channelizing islands should be large enough to store either bicycles with trailers or groups of bicyclists, providing at least six feet of length, but ideally at least ten feet. The use of raised crossings is recommended to improve visibility of pedestrians and bicyclists.
Facility Design Guide [54]	The document provides guidance related to the use of channelized turn lanes in Minnesota, including: <ul style="list-style-type: none"> • While channelization may reduce conflicts for drivers, it may also result in potential complexity for pedestrians and bicyclists. • Channelizing islands that are not intended to provide refuge for pedestrians should not block conflicting crossings. • Channelizing islands intended to serve as refuge should include an accessible route and allow for enough room to incorporate accessible signal features. • Modern low angle of entry channelized designs can be considered as a strategy to mitigate concerns related to relatively large turning radii. • <i>Section 8C.9.7.6</i> details the use of CRTs in the state. The guidance notes that these designs are often used to increase capacity or accommodate atypical geometry (such as a skewed intersection). These designs are discouraged in areas where pedestrians are expected to cross due to concerns related to increased turning speeds and reduced yielding compliance. If a channelized design is used, the inclusion of warning signs, pavement markings, and or traffic control devices should be considered to emphasize the crossing to drivers. The document also identifies the specific concerns related to pedestrians with vision impairments or other disabilities.
Minnesota MUTCD [55]	CRTs are discussed within several portions of the Minnesota MUTCD, including: <ul style="list-style-type: none"> • <i>Section 2B.9</i> allows for the use of yield signs for CRTs even if other lanes are controlled by a stop sign or traffic signal. This section also provides for the optional use of a second stop or yield sign within the channelizing island. • <i>Figure 2A-3</i> identifies the typical location of a yield sign at a channelized turn. • <i>Section 4E.12</i> provides the support that audible beacons can cause confusion at locations with channelized turn lanes. • <i>Section 2C.40</i> provides for the optional use of a NO MERGE AREA W4-5P supplementary plaque based on engineering judgement when an acceleration lane is not provided, and one may be expected by drivers.
Traffic Engineering Manual [56]	The Traffic Engineering Manual notes that in general, crosswalks at CRTs should follow the same criteria as unsignalized crosswalks. Typically, this involves not installing crosswalk markings across channelized right-turn movements. In cases where crosswalks are included, signing or other traffic control enhancements as well as geometric design elements should attempt to control speeds.

4.2 Minnesota Local Roadway Agency Focus Group and Survey

Feedback from local roadway agencies within Minnesota was also obtained to gain an improved understanding of the practical issues associated with installation and maintenance of CRTs within the state. This feedback was collected during a virtual focus group meeting with personnel from local agencies in Minnesota that was held on May 28, 2024. Participants were recruited via email invitation that was sent to members of the Traffic Safety Committee of the City Engineers Association of Minnesota (12 members) and the Highway Safety Committee of the Minnesota County Engineers Association (11 members). The meeting was led by members of the research team and was attended by 13 participants.

During the virtual focus group, a series of design strategies for CRTs, including example images of actual locations where each design strategy has been employed from across the United States. Participants were ultimately asked to provide feedback for each strategy, including (1) the accessibility, safety, and comfort for pedestrians and bicyclists, (2) whether any specific modifications or enhancements could be made to improve each design strategy, and (3) identify contexts where each strategy may not represent a feasible design alternative. The discussion was moderated by members of the research team such that all participants were offered an opportunity to contribute, beginning with a general discussion of CRTs before transitioning into a discussion of specific strategies. In addition to the stakeholder focus group virtual meeting, feedback was also obtained from 14 local roadway agencies in Minnesota via the roadway agency survey (**Appendix A**). A total of 20 local agencies, which are indicated in **Figure 30**, participated in the focus group meeting and/or the survey, including 10 counties, nine cities, and one MPO. The list of participants is provided in **Appendix B**. The collective findings from the local agency focus group and online survey are summarized in the following subsections.

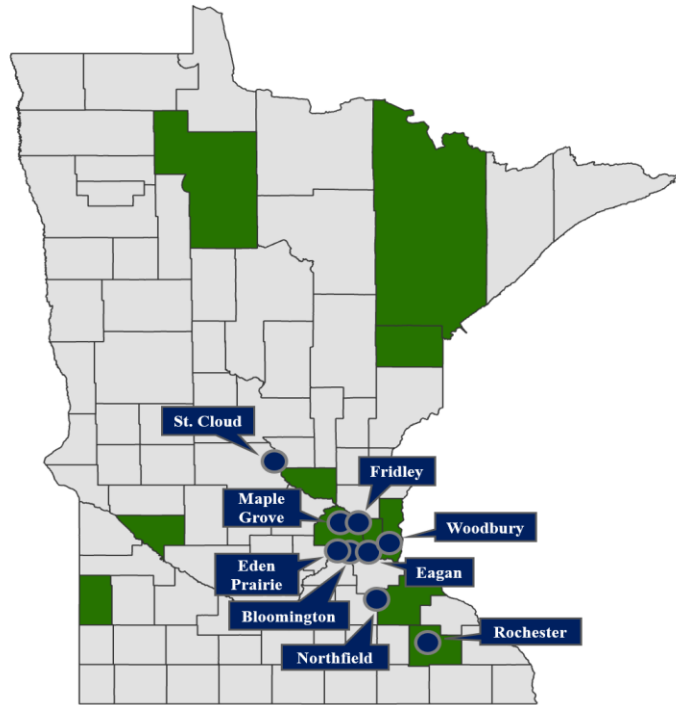

Figure 30. Map of participating local roadway agencies in Minnesota.

4.2.1 Perspectives and Current Practices of Minnesota Local Agencies

Eight of the 14 responding local agencies within Minnesota indicated that they currently utilize CRTs at signalized intersections where pedestrians are expected to cross. As expected, most of the agencies currently maintaining CRTs tended to be within more developed areas of Minnesota, while those agencies that do not utilize CRTs were predominately counties located in rural areas with only a limited number of signalized intersections. Detailed comments related to the use of CRTs from agencies obtained as a part of the focus group meeting or survey are summarized below:

- Many agencies expressed concerns related to pedestrians (particularly those with vision disabilities), and acknowledged and there has been a general trend to either deploy mitigation strategies (such as the modern low angle of entry design) or minimize the implementation of CRTs at locations when pedestrians are expected to cross.
- The City of Bloomington noted that CRTs are used occasionally in situations where designers have sought the additional capacity provided by operating left and right-turning movements concurrently. This scenario often occurs at freeway service interchange terminals and would typically include an acceleration lane.
 - While several CRTs remain in place across the city, they have been removed in specific circumstances along routes where pedestrians are often present, particularly along school routes.
 - Anecdotally, relatively few pedestrian crashes have occurred at CRTs within the city, despite the perception of safety concerns.

- Certain CRTs have experienced a concentration of rear end collisions, which has consequently led to their removal.
- The City of Rochester noted that CRTs have been used along arterial routes in scenarios where queueing would otherwise prevent vehicles from completing right turn on red movements. These designs would not typically incorporate an associated acceleration lane.
- St. Louis County identified that there are a number of signalized intersections with CRTs in the county, typically where the additional capacity was sought by designers.
 - The county is currently working with MnDOT to remove the CRT as a part of a reconstruction project for a four-leg signalized intersection in an effort to reduce turning speeds. This location was not currently benefiting from the additional capacity provided by the CRT.
 - The county also noted that CRTs can offer the benefit of breaking up a crossing into smaller segments, even if the total crossing distance remains similar compared to a conventional design.
- Hennepin County and the City of Maple Grove indicated that there has been a push in recent years to either remove CRTs or move towards the modern low angle of entry design.
- Ramsey County noted that CRT designs may offer potential advantages and disadvantages with respect to the placement of the crosswalk and related sight lines for pedestrians.
- The City of Eagan noted that CRT designs can often require more right-of-way compared to conventional designs.
- Washington County identified three scenarios where a CRT would be most likely be considered as a potential design alternative:
 - situations where additional capacity is sought by designers,
 - locations where skew would lead to excessively long crossing distances, or
 - scenarios where a permissive left turn movement would have priority over opposing right-turn movements.
- The Rochester Olmsted Council of Governments noted that there has been increasing public concern, but no specific policy has currently been established within the agency.

4.2.2 CRT Design Features and Mitigation Strategies

In addition to general questions related to the use of CRTs, the Minnesota local agency focus group participants and survey takers were also asked to indicate the use of specific design features and crossing enhancements. These findings are summarized in the subsections that follow.

4.2.2.1 Type of Traffic Control at CRTs

When asked about the type of traffic control utilized on the channelized right-turn lane itself (not specifically at the crosswalk), consistent with the findings from outside of Minnesota, yield control represents the predominant traffic control type employed at CRTs among in-state local agencies (**Table 13**). Uncontrolled designs are used sparingly in specific situations in combination with acceleration lanes, while stop signs are rarely used at channelized right-turn lanes by local agencies in the state, even

though Minnesota state law requires motorists to “stop to yield” for pedestrians crossing at unsignalized crosswalks. Signal control is employed by local agencies in Minnesota in specific situations, such as where dual channelized right-turn lanes serve relatively high right-turning volumes.

Table 13. Type of Traffic Control Used by Minnesota Local Agencies at CRTs (N = 8)

Control Type	Never	Rarely	Sometimes	Frequently	Unsure
No Control	12.5%	50.0%	0.0%	25.0%	12.5%
Yield Control	0.0%	0.0%	12.5%	75.0%	12.5%
Stop Control	75.0%	12.5%	0.0%	0.0%	12.5%
Signal Control	50.0%	25.0%	12.5%	0.0%	12.5%

4.2.2.2 Crosswalk Surface Treatments

Survey participants were asked to indicate the use of common crosswalk surface treatments. High-visibility crosswalk markings (such as zebra or ladder style markings) represent the most common crosswalk surface enhancement employed by the surveyed local roadway agencies within Minnesota (Table 14). There is only limited current use of raised crosswalks, advanced yield markings, and textured crosswalks by these agencies.

Table 14. Minnesota Local Agency Crosswalk Surface Treatments for CRTs (N = 8)

Surface Treatment	Never	Rarely	Sometimes	Frequently	Unsure
High-Visibility Crosswalk Markings	0.0%	0.0%	12.5%	87.5%	0.0%
Raised Crosswalks	75.0%	25.0%	0.0%	0.0%	0.0%
Advance Yield Markings	50.0%	37.5%	12.5%	0.0%	0.0%
Texturing Crosswalks	75.0%	25.0%	0.0%	0.0%	0.0%

Detailed comments related to the use of crosswalk surface treatments at CRTs from agencies obtained as a part of the focus group meeting or survey are summarized below:

- The City of Rochester expressed that the agency would like to employ raised crossings more often but have experienced difficulties in obtaining state aid funding associated with the vertical component of the raised crossing impacting design speed requirements.
 - The city is currently working with MnDOT to install raised crosswalks at a four-leg intersection with CRTs along the state aid network.
- Ramsey County indicated that they are working to implement raised crossings at a multilane roundabout.
- Several agencies noted that while they have sought the use of raised crossings, winter maintenance concerns related to snowplows have limited their applicability to intersections in Minnesota.
- The City of Eden Prairie noted that Minnesota’s traffic engineering manual includes language that crosswalk markings should generally not be included at CRTs. This guidance was based on a prior study conducted by the department with the intent to minimize maintenance costs related to maintaining these markings.

4.2.2.3 Crosswalk Placement

Survey participants were asked to indicate the use of common crosswalk placement strategies, which included three possible locations (upstream, centered, and downstream of the cross street) and two possible geometric orientations (perpendicular to the sidewalk and parallel to the sidewalk), as depicted in **Figure 11**.

The responses from the Minnesota local agencies were in general agreement with those obtained from outside Minnesota. Specifically, the center-perpendicular crosswalk placement (i.e., the crosswalk aligns in the center of the channelizing island and is perpendicular to traffic, shown in Option 3 of **Figure 11**), represents the most common approach employed by local agencies within the state (**Table 15**). Other placement strategies are sparingly used depending on site-specific conditions.

Table 15. Minnesota Local Agency Crosswalk Placement at CRTs (N = 8)

Placement	Never	Rarely	Sometimes	Frequently	Unsure
Upstream - Parallel	100.0%	0.0%	0.0%	0.0%	0.0%
Upstream - Perpendicular	75.0%	12.5%	0.0%	12.5%	0.0%
Center - Perpendicular	0.0%	0.0%	0.0%	100.0%	0.0%
Downstream - Parallel	87.5%	12.5%	0.0%	0.0%	0.0%
Downstream - Perpendicular	75.0%	25.0%	0.0%	0.0%	0.0%

Detailed comments related to crosswalk placement at CRTs from agencies obtained as a part of the focus group meeting or survey are summarized below:

- Several agencies indicated that crosswalks are required to be placed within 20 feet of the cross street, which often prevents placement on the upstream side of the island.
- The City of Bloomington expressed concerns with placing crosswalks at the downstream end of CRTs in scenarios without signal control due to the fact drivers will be looking to identify gaps in cross street traffic.
- Washington County noted that there are locations that deviate from the commonly used center-perpendicular placement due to site-specific considerations, such as skew or minimizing out-of-direction travel distances from adjacent trails connected by the crossing.

4.2.2.4 Sign and Beacon Treatments

Survey participants were asked to indicate the frequency of use among several crosswalk sign and beacon strategies for CRTs within their jurisdiction at signalized intersections where pedestrians are expected to cross (as discussed in **Section 2.2.3**). The findings from the survey of Minnesota local agencies are presented in **Table 16**.

Table 16. Minnesota Local Agency Crosswalk Signs and Beacons Used at CRTs (N = 8)

Treatment	Never	Rarely	Sometimes	Frequently	Unsure
R1-5 Signs	37.5%	25.0%	37.5%	0.0%	0.0%

In-Street R1-6 Signs	50.0%	50.0%	0.0%	0.0%	0.0%
Curbside R1-6 Signs	50.0%	25.0%	12.5%	12.5%	0.0%
W11-2 Signs	0.0%	37.5%	37.5%	25.0%	0.0%
Overhead Amber Beacons	87.5%	12.5%	0.0%	0.0%	0.0%
Sign-Mounted Amber Beacons	75.0%	25.0%	0.0%	0.0%	0.0%
RRFBs	75.0%	12.5%	12.5%	0.0%	0.0%
PHBs	75.0%	12.5%	0.0%	0.0%	12.5%

W11-2 pedestrian crossing warning signs represent the most common signing enhancement, while R1-5 and R1-6 signs are used in specific circumstances. Detailed comments related to crosswalk signs and beacons at CRTs from agencies obtained as a part of the focus group meeting or survey are summarized below:

- The City of Bloomington noted that along CRT designs that are relatively short, the use of pedestrian warning signs is discouraged in order to not occlude the yield sign for traffic control.
- The City of Rochester noted that for MUTCD compliance, R1-5 signs would typically only be used for multilane scenarios where an advance stop bar is also used. Instead, W11-2 pedestrian warning signs are more frequently used, particularly at uncontrolled crosswalks.
- Hennepin County noted that they have used R1-5 signs at midblock crosswalks across multilane facilities, but not at an intersection.
- Washington County indicated that they typically do not use pedestrian warning signs at CRTs with yield control.
- No local agencies in Minnesota have employed RRFBs in a CRT context but acknowledged that this could represent a potential option to consider (particularly if RRFBs become the predominant treatment at roundabouts to ensure consistency).

4.2.2.5 Traffic Signal Strategies

Survey participants were asked to indicate the frequency of use among several traffic signal strategies for CRTs within their jurisdiction at signalized intersections where pedestrians are expected to cross. The responses are indicated in **Table 17**. APS devices are used consistent with the MUTCD and Public Right of Way Access Guidelines (PROWAG) requirements.

Table 17. Minnesota Local Agency Traffic Signal Strategies for CRTs (N = 8)

Treatment	Never	Rarely	Sometimes	Frequently	Unsure
Push Buttons	50.0%	12.5%	12.5%	25.0%	0.0%
Accessible Pedestrian Signals	50.0%	25.0%	12.5%	12.5%	0.0%
Leading Pedestrian Intervals	75.0%	0.0%	25.0%	0.0%	0.0%
Static RTOR Restrictions	62.5%	12.5%	25.0%	0.0%	0.0%
Dynamic RTOR Restrictions	62.5%	37.5%	0.0%	0.0%	0.0%
Green Ball Signal Indications	62.5%	37.5%	0.0%	0.0%	0.0%
Green Arrow Signal Indications	75.0%	0.0%	25.0%	0.0%	0.0%
Flashing Yellow Arrow Signal Indications	87.5%	0.0%	12.5%	0.0%	0.0%
Roadside Mounted Signals	87.5%	12.5%	0.0%	0.0%	0.0%

Overhead Signals	87.5%	12.5%	0.0%	0.0%	0.0%
Overhead and Roadside Signals	87.5%	12.5%	0.0%	0.0%	0.0%

4.2.2.6 Geometric Design Strategies

Survey participants were also asked to indicate utilization preferences for various geometric design strategies utilized at CRTs, as discussed in **Section 2.2.4**, and included deceleration and acceleration lanes, alternative entry angles, lane narrowing/radius reductions, and methods for providing pedestrian pathways within the channelized island. The survey results are displayed in **Table 18**.

Table 18. Minnesota Local Agency Geometric Design Strategies for CRTs (N = 8)

Treatment	Never	Rarely	Sometimes	Frequently	Unsure
Deceleration Lane	0.0%	0.0%	37.5%	62.5%	0.0%
Acceleration Lane	37.5%	37.5%	25.0%	0.0%	0.0%
Cut Through Island	12.5%	37.5%	37.5%	12.5%	0.0%
Ramped Island	0.0%	0.0%	25.0%	75.0%	0.0%
Low Angle of Entry	0.0%	62.5%	0.0%	37.5%	0.0%
High Angle of Entry	12.5%	12.5%	62.5%	12.5%	0.0%
Lane Narrowing	50.0%	25.0%	12.5%	12.5%	0.0%

Consistent with the nationwide findings, deceleration lanes represent a common feature of CRTs among Minnesota local agencies. Acceleration lanes are used less frequently, primarily at locations that employ uncontrolled channelized right-turn lanes. Local agencies in Minnesota tend to use the ramped island design as opposed to the cut through approach in order to accommodate snow removal. Similar to the nationwide survey results, conventional high angle of entry designs remain in place across the state, however; local agencies are working to increase the use of the modern low angle of entry geometric design. Detailed comments related to geometric treatments for CRTs from agencies obtained as a part of the focus group meeting or survey are summarized below:

- The City of Eden Prairie noted that they recently completed a retrofit of a CRT to convert the facility to a modern low angle of entry design.
- Washington County noted that winter maintenance at locations with the modern low angle of entry design can be difficult in scenarios where the cross street is a divided two-lane facility, resulting in a relatively small radius for snowplows to navigate.
- The City of Rochester noted that they are attempting to replace CRT facilities with the conventional high angle design with the modern low angle design.
- The City of Eagan discussed the crash experience at a CRT location that was retrofit from a conventional high angle of entry design with a modern low angle of entry design. A pattern of right-turn collisions occurred both before and after the retrofit, which was ultimately removed in favor of a conventional non-channelized design to address safety performance.
- The City of Bloomington discussed the crash experience at a location with the modern low angle of entry design, where vehicles were encroaching into the cross street resulted in angle collisions.

To address this concern, Washington County has used edgeline extensions along the cross street at the end of the channelized lane.

- In general, Minnesota local road agencies have minimized the use of acceleration lanes at CRTs.
- Hennepin County noted that they are currently evaluating the inclusion of mountable truck aprons to accommodate turning radii at CRT designs (such as the example in **Figure 31**). The county is currently in the process of working with ADA staff at MnDOT to ensure these do not represent a trip hazard for pedestrians with disabilities.



Figure 31. Example of lane narrowing/radius reduction with truck apron.

Chapter 5: Vulnerable Road User Focus Groups

It was also critical to obtain feedback specific to vulnerable road users, including pedestrians, bicyclists, and disabled persons, who must navigate CRTs and serve to benefit from design or traffic control improvements. This was achieved through a series of four virtual focus group sessions that sought to identify specific issues related to navigation of CRTs, in addition to potential mitigation strategies. The four virtual focus group sessions were held between May 31st and June 10th of 2024 and were attended by advocates (including representatives of groups or committees), service organizations, orientation/mobility specialists for persons with visual impairments, and pedestrians with disabilities, including visual impairments and wheelchair users. Additionally, agency experts involved with planning, design, or compliance for active transportation modes participated in these feedback sessions, including personnel from the Minnesota DOT, Massachusetts DOT, Washington State DOT, and Montgomery County, Maryland. A total of 18 individuals provided feedback as a part of this process, and a complete list of participants is included in **Appendix C**. It should be noted that three stakeholders were not able to participate in the virtual focus group meetings and instead provided feedback via email.

The feedback sessions were moderated by members of the research team such that all participants were offered an opportunity to contribute. Each of the four focus group sessions began with a general discussion of the advantages and disadvantages of CRTs in urban and suburban environments, interactions with right-turning vehicles at intersections with and without channelized right-turn lanes, and scenarios where any specific design features of CRTs helped or hindered the ability of pedestrians to safely complete crossing movements. Additionally, participants who represented roadway agencies were asked about their agency's current policies and practices related to CRTs. From there the discussion shifted to the benefits and drawbacks of specific design or traffic control strategies, during which a series of images depicting various CRT designs or traffic control strategies were presented to the participants. The participants were asked which strategies they preferred and what modifications could be made to improve safety, accessibility, or comfort. Images taken from Google aerial imagery and/or street view of actual locations where each design strategy has been deployed from across the United States were utilized whenever possible. The findings obtained as a part of these feedback sessions are collectively summarized in the following subsections, including general commentary followed by discussion of specific strategies.

5.1 Current Agency Practices

The perspectives and current practices related to the use of CRTs as noted by the participants representing the Minnesota DOT, Massachusetts DOT, Washington State DOT, City of Minneapolis, and Montgomery County, Maryland is summarized as follows:

- MnDOT is currently in the process of reviewing CRTs across the state, along with agency policies and practices.

- CRTs are currently considered for implementation at intersections with considerable skew to minimize excessively long crossing distances. This may provide advantages for pedestrians by breaking the crossing into smaller segments.
- Recommendations are being made to either remove or retrofit with an improved design, when feasible, as a part of projects at intersections where they exist. Small channelizing islands can create difficulties with incorporating all the required traffic control devices (such as signal poles or detectable warning devices) as a part of upgrade projects.
- The City of Minneapolis is in the process of removing select CRTs at locations with a history of traffic crashes. The CRT located at the intersection of 11th Avenue and East Hennepin in Minneapolis was specifically noted as a location where the CRT has been targeted for removal.
- Montgomery County, Maryland is not installing any new CRTs and generally seeks to remove existing channels when practical as a part of projects that include intersections with CRTs.
 - This policy is largely driven by the agency’s vision zero commitment given concerns related to pedestrians and bicyclists.
- Although the Massachusetts DOT maintains a number of existing intersection locations with CRTs, the agency typically does not install new CRTs unless there are site-specific conditions (such as considerable skew) where the channelized design would mitigate concerns related to excessively large corner radii.
- The Washington State DOT is generally avoiding the use of CRTs and has recently updated the agency’s design manual to include guidance that CRTs should be removed when feasible or otherwise retrofit to minimize turning speeds. The following reasons for this were noted:
 - CRTs are often uncontrolled with corner radii that allow for relatively high turning speeds, resulting in a crossing that is particularly difficult for pedestrians.
 - While crossings may be split up into smaller segments, the total crossing distance (and thus total exposure) can be larger at CRTs compared to conventional designs.
 - The use of CRTs can result in incorrect orientation for pedestrians, particularly those with visual or cognitive limitations.
 - Washington DOT is also currently modifying design guidance to meet the revised PROWAG requirements for dual channelized right-turn lanes.

5.2 General Pedestrian Considerations

Participants noted that pedestrians should be afforded similar safety, mobility, and comfort at locations with CRTs as locations with conventional right-turn designs. However, it was generally acknowledged during the feedback sessions that CRTs, particularly those without any traffic control on the channelized lane, represent potential safety concerns for pedestrians and bicyclists. While separating right-turning vehicles out from the main intersection may reduce certain vehicle-pedestrian conflicts, the channelized lane often results in higher turning speeds and a difficult visual search angle for drivers seeking an appropriate gap in cross-traffic. This contributes to challenges for pedestrians interacting with drivers while attempting to cross, which is amplified by inconsistencies in the use and placement of traffic control devices and other design features at CRTs. Winter conditions in Minnesota were also noted as a general concern for pedestrians traversing CRTs as snow and ice often obstructs the pedestrian

pathway, creating additional navigational issues, particularly for persons with disabilities. Collectively, such issues results in some pedestrians, particularly those with disabilities, avoiding CRTs.

5.3 Considerations for Pedestrians with Vision Impairments

The concerns related to navigating CRTs are particularly problematic for persons with vision impairments. In general, it was noted that CRTs represent an uncomfortable crossing environment for visually impaired pedestrians. Visually impaired pedestrians have two principal issues at CRTs, which include 1.) identifying and orienting to the desired crosswalk and 2.) indicating to drivers of the desire to cross. These issues are exacerbated by inconsistency in the use and placement of traffic control devices, crosswalks, and other design features at CRTs. As a result, persons with visual impairments tend to avoid crossing at CRTs whenever possible, often taking an indirect route around the intersection or using an alternative intersection. The participants provided a number of additional considerations with respect to visually impaired pedestrians attempting to navigate CRTs, which are provided in the following subsections.

5.3.1 Orientation and Wayfinding

- The orientation and mobility specialists noted that visually impaired pedestrians are typically trained to use audible clues to first determine the presence of the channelized right-turn lane based on the separation between the through traffic stream and right-turning vehicles, which, similar to roundabouts, can be particularly challenging where there is a significant amount of traffic noise from the other lanes.
- Touch and drag cane techniques are then used to identify the crosswalk, moving along the curbline until the crosswalk is located. Inconsistent placement and orientation of the crosswalk within the channelized right-turn lane complicates the search process, and often causes visually impaired pedestrians to miss the crosswalk on the first pass, requiring them to double-back along the curb line until the crosswalk is located.
- Upon reaching the island, the pedestrian moves to identify the curb line along the far side of the island and listen for traffic to determine their orientation along the desired crossing path. This task is particularly challenging for visually impaired pedestrians at locations where traffic is not aligned with the crossing path, including skewed intersections where channelizing islands on the far side of the intersection are not perpendicular to traffic. Furthermore, lanes where traffic is not present to provide these audible clues or where drivers behave in unexpected ways can be especially difficult to cross. In cases such as these, pedestrians with visual impairments may need assistance to safely cross.
- Tactile walking surface indicators (TWSI) were identified as another potential option to consider at locations where the typical cues used by visually impaired pedestrians to detect the crosswalk location (such as adjacent road noise, detectable edges, or roadway geometry/alignment) are absent or misleading. An example of this treatment being navigated by a visually disabled pedestrian at a roundabout is shown in **Figure 32**. Heating elements may be incorporated to prevent snow and ice buildup.



Figure 32. Example of tactical walking surface indicators at a roundabout.

- It was noted that techniques for crossing CRTs may be outside of common training provided to visually impaired pedestrians.
- Furthermore, guide dogs may have difficulty identifying the appropriate departure crosswalk upon entering the channelizing island.

5.3.2 Interactions with Drivers

- Pedestrians with vision impairments struggle to audibly identify the intent (e.g., yielding the right-of-way or proceeding through) of drivers approaching the crosswalk on the channelized right turn lane which, in turn, presents challenges with initiation of the crossing maneuver. This is particularly problematic at locations that do not include deceleration lanes in advance of the channelized right-turn lane, as the right-turning vehicles are mixed with through vehicles on the approach making them difficult to distinguish.
- In such cases, visually impaired pedestrians may be unaware that vehicles have yielded upstream of the crossing, particularly where there is a significant amount of traffic noise from other lanes. This can lead to awkward and uncertain interactions where drivers may become impatient with the pedestrian who had misunderstood the driver's intent and continued to wait for a safe gap to cross.
- While it was acknowledged that the use of sound strips within the channelized right-turn lane may not be practical in Minnesota due to concerns with damage from snow plows, alternative designs such as corrugations milled into the pavement of the deceleration lane was suggested as a possible treatment to assist visually impaired pedestrians to interact with right-turning drivers and identify safe gaps.
- Locations with low traffic volumes along the cross street may allow approaching drivers to traverse the CRT at higher speeds, creating further issues with driver interaction and gap selection for visually impaired pedestrians waiting to cross.
- Pedestrians with disabilities (including vision and mobility) would prefer strategies that encourage drivers to stop for pedestrians attempting to cross.

5.4 Considerations for On-Road Bicyclists

Compared to conventional right turns, CRTs help reduce the threat of right-turning vehicles colliding with bicyclists while completing the right turn (i.e., “right hook” collision). However, additional consideration must be given to ensure safe accommodation for bicyclists traversing through intersections with CRTs. It was widely noted that bicyclists often feel uncomfortable at CRTs due to interactions with vehicles at the point of entry into the deceleration lane upstream of the intersection or conflicts with drivers overtaking bicyclists within the channelized lane, although it should be noted that such issues would apply to all right-turn lanes.

Additionally, there is no consensus regarding what to do with the bicycle lane upon reaching the channelized turn lane. Commonly, the bicycle lane is discontinued at the start of the right-turn lane, indicated either by dotted lines or no markings at all, and is re-established adjacent to the rightmost through-lane at the channelized island. The Massachusetts and Washington DOTs have sought methods to better incorporate bicycle facilities at intersections with channelized right-turn lanes, including connecting bicycle lanes with sidepaths upstream of intersections to allow bicyclists who feel uncomfortable traveling within the roadway at these locations move to facilities outside of the traveled way. However, the participating orientation and mobility specialists noted that this could result in additional conflicts on shared use paths between bicyclists and pedestrians with disabilities. Montgomery County has even gone so far as to remove the CRT to better accommodate bicycle facilities.

5.5 Traffic Control Considerations

Participants were then asked to discuss the advantages and disadvantages associated with each of the four general types of traffic control utilized at CRTs, including uncontrolled designs, yield control, stop control, or signal control. Commentary from participants related to the various types of traffic control is summarized below:

- There was general consensus that crossing CRTs that are controlled by a yield sign or uncontrolled (especially) can result in pedestrians feeling vulnerable while completing the crossing movement.
- Transportation agency personnel noted two potential issues with the use of yield signs at crosswalks within the channelized right-turn lane, which should thereby restrict their use at crosswalks in Minnesota:
 - Although several examples of yield signs being utilized at crosswalks were presented, yield signs are intended for drivers entering into the intersecting street, and are not intended to control the right-of-way at the crosswalk. As such, yield signs within the channelized right-turn lane should be positioned near the entry point to the intersecting street.
 - Minnesota state law requires drivers to “stop to yield” for pedestrians crossing at unsignalized crosswalks. However, participants generally agreed with the impracticalities of utilizing a stop sign at crosswalks within channelized right-turn lanes.

- There was general agreement that the use of signal control at the crosswalk within the channelized right-turn lane represents would provide the highest level of safety and accessibility for pedestrians, despite the fact that this could impact pedestrian delay depending on the signal phasing. However, pedestrians with disabilities (including vision and mobility) consider the safety and accessibility of crossings to be paramount over excessive delays, and thus, consider signalization of the crosswalk as the preferred type of traffic control at CRTs.
- The Massachusetts DOT and Washington DOT are pushing towards signalization of CRTs, including the use of appropriate APS devices, in order to ensure that pedestrian accessibility requirements are met.
- Montgomery County expressed caution in that there may be an expectation from drivers that CRTs are generally controlled by a yield sign, and therefore, drivers may not be prepared for or respect locations that include signal or stop control.

5.6 Crosswalk Surface Treatments

Participants were presented with a series of images and graphics depicting commonly used crosswalk surface treatments, including high-visibility crosswalk markings, advance yield markings, textured crosswalks, and raised crossings. Feedback from participants related to crosswalk surface treatments is summarized in the subsections that follow.

5.6.1 High-Visibility Crosswalk Markings

- Participants noted the importance of marking the crosswalks at CRTs using some form of high-visibility crosswalk markings, as opposed to the traditional crosswalks formed with two parallel markings perpendicular to traffic.

5.6.2 Advance Yield Markings

- The Washington DOT will occasionally use advance yield markings as a part of CRT designs depending on the geometric configuration of the site.
- However, participants from Minnesota noted that because advance yield markings are used rarely in Minnesota, the intended message may not be well understood by road users.

5.6.3 Textured Crosswalks

- Textured crosswalks, which are formed using a texturized pattern that is typically imprinted into the crosswalk surface, are not commonly utilized by any of the participating agencies, and are unlikely to be a feasible option in Minnesota due to snowplowing and other maintenance concerns.
- Orientation and mobility specialists expressed that pedestrians with vision impairments may have trouble recognizing the intent of the textured crosswalk unless the cane is constantly in contact with the surface.

5.6.4 Raised Crossings

Considerable support was provided towards the use of raised crossings at channelized crossings by several participants, including transportation agencies, pedestrian and bicycle advocates, and orientation and mobility specialists. However, several issues were noted, including those related to winter maintenance and wayfinding by visually impaired pedestrians. Specific comments are provided as follows:

- The Washington DOT is exploring the use of raised crosswalks, particularly as a method to address the new PROWAG requirements at multilane approaches at CRTs and roundabouts.
 - The department emphasized that the grade break and ramp design of a raised crossing can help to ensure the treatment is effective for speed reductions, even in cases where the total height of the raised crossing is relatively low.
 - The department also noted that transit agencies have previously pushed back on the use of raised crossings due to concerns related to buses bottoming out after passing over the crossing, but these issues should be mitigated with appropriate designs.
- The department is currently developing a standard based on designs used by the Hawaii DOT as well as the City of Boulder, Colorado.
- MnDOT noted that raised crossings are currently not used along state routes due to concerns with snow plow operations. However, the department is currently exploring ways to employ this treatment. Other participants agreed that the challenges surrounding snow plows should not preclude the use of raised crosswalk designs if such concerns can be mitigated.
- Orientation and mobility specialists recognized the advantages of raised crosswalks, but noted that wayfinding methods used by visually impaired pedestrians must be considered.
 - For example, designs without any slope before the crosswalk or misaligned detectable warning devices can lead to potential confusion when orienting.
 - Guide dogs typically can effectively navigate raised crossings.
 - The sloped edges of raised crosswalks may help keep visually impaired pedestrians on the intended path.
 - The raised crosswalk must be designed using various conspicuity measures to ensure that approaching drivers reduce speeds in advance of the crossing.
 - Raised crossings in Boulder, CO (**Figure 10**) and Harrisburg, PA (**Figure 33**) were cited as a particularly effective designs for visually impaired pedestrians.



Figure 33. North 7th Street in Harrisburg, Pennsylvania [3].

5.7 Crosswalk Placement

Participants were presented with a series of graphics depicting commonly used crosswalk placement strategies, which included three possible locations (upstream, centered, and downstream of the cross street) and two possible geometric orientations (perpendicular to the sidewalk and parallel to the sidewalk). Feedback related to crosswalk placement strategies is summarized below:

- Participants noted that regardless of the crosswalk placement selected by the designer, it is critical to ensure that the curb ramps and all other ADA features align with the intended path of crossing. There was also a general caution against crosswalk placements that introduce out-of-direction travel for pedestrians, which introduces potential wayfinding challenges for pedestrians with vision impairments.
- There was general support by most participants for the center-perpendicular placement, which was found to be the most common crosswalk placement at channelized right-turn lanes, both within Minnesota and elsewhere throughout the U.S. This support for center-perpendicular crosswalk placement was based on the following:
 - Center-perpendicular placement minimizes the total crossing distance when crossing the channelized right-turn lane.
 - Center-perpendicular placement helps ensure that the crossing path is directed to the center portion of the channelizing island to maximize the likelihood that a pedestrian with vision disabilities will reach the island.
 - Center-perpendicular placement helps place pedestrians in a position where approaching drivers can better identify the pedestrian's desire to cross.
 - Center-perpendicular placement can better accommodate space for signal equipment.
- The greatest negative attribute associated with center-perpendicular crosswalk orientation is that it often introduces out-of-direction travel for pedestrians. Some participants noted potential benefits of using upstream or downstream parallel designs to minimize out-of-direction travel for pedestrians. Parallel designs minimize out-of-direction travel by positioning the crosswalk such that it effectively allows pedestrians to continue along the original travel path without turning.

- Downstream parallel crosswalk placements were noted to provide drivers with more time to identify a pedestrian attempting to cross and may also provide pedestrians with a better view of approaching vehicles.
- Upstream parallel crosswalk placements were discouraged from use by several participants as this orientation often results in pedestrians facing away from oncoming traffic while completing the crossing movement.
- Upstream perpendicular crosswalk placement garnered support from several participants, who noted that such designs may help pedestrians to be more easily identified by approaching drivers, and thus, be more comfortable for pedestrians with visual impairments. However, as previously noted, perpendicular designs introduce out-of-direction travel, presenting potential wayfinding challenges for pedestrians with vision impairments.
- Montgomery County noted that crosswalks are provided in two locations at select channelized right-turn lanes with large radii, such as that shown in **Figure 34**.

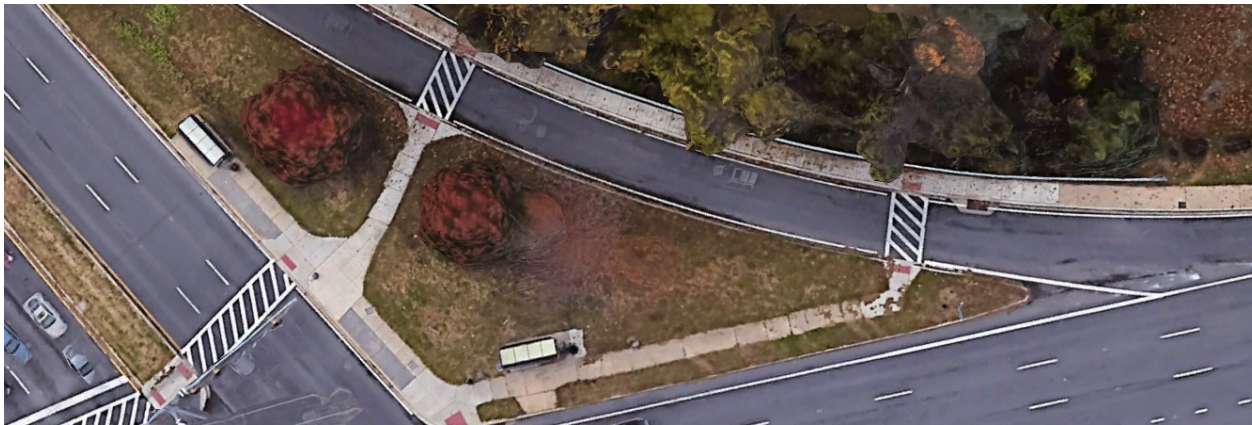

Figure 34. Veirs Mill Road and Connecticut Avenue in Silver Spring, Maryland [3].

5.8 Crosswalk Signs and Beacon Treatments

Participants were presented with a series of graphics and images depicting commonly used crosswalk sign and beacon treatments found in the 11th edition of the MUTCD [28]. This included the use of MUTCD W11-2 signs, R1-5 signs, R1-6 signs (placed in the street or along the curb), R10-15 series signs, as well as RRFBs and PHBs. Feedback from participants related to the various crosswalk signs and beacons is summarized in the following subsections.

5.8.1 Signs

- There was general sentiment from participants that while warning signs may provide some enhancement of the crosswalk at CRTs, they are often insufficient to influence driver behavior.
- The traditional W11-2 *Pedestrian Crossing Warning* sign is the most commonly used sign to enhance crosswalks located at CRTs, often at locations where pedestrian safety is of concern.
 - Orientation and mobility specialists expressed support for the use of W11-2s as a well-understood treatment to emphasize the crosswalk at channelized right-turn lanes.

- The W11-2 sign was preferred over the R1-6 (in-street) sign placed on the curb as either the R1-6 sign or the pedestrian could be occluded to the driver, depending on whether the sign is placed upstream or downstream of the crosswalk.
- Regulatory signs, such as the R1-5 *Yield Here to or Stop Here for Pedestrians* signs were generally viewed favorably as a crosswalk enhancement.
 - Crosswalk laws in Minnesota would require the “stop” variant (R1-5b/c) to be used.
 - The variants of the R1-5 sign that include the pedestrian symbol were generally preferred over those with “pedestrian” stated as text.
 - However, the MUTCD only allows their use at uncontrolled crosswalks on multi-lane approaches, including at channelized right-turn lanes, as a means of reducing multiple-threat collisions.
 - Introduced in the 11th Edition of the MUTCD, the R10-15 *Turning Vehicles Yield to/Stop for Pedestrians* signs depicted in **Figure 13** was deemed a viable alternative to the R1-5 for use on single channelized right-turn lanes.

5.8.2 Beacons

- There was general support for beacon treatments, such as RRFBs and PHBs, as they send a clear message to all road users about the importance of pedestrian safety.
- Participants emphasized the importance of providing APS devices with PHBs or RRFBs in order for them to be helpful for pedestrians with vision impairments.
- Several participants noted that RRFBs are less desirable because they do not include the regulatory stop indication provided by the PHB or a full traffic signal. Montgomery County is moving away from the use of RRFBs for this reason.
- While PHBs were generally viewed more favorably than RRFBs, there are concerns with driver comprehension with PHBs due their limited use nationwide, particularly at channelized right-turn lanes, roundabouts, and other similar intersection scenarios.
- While the Washington DOT does not commonly use pedestrian beacon treatments at CRTs, there are select instances where RRFBs have been implemented. It was noted that due to maintenance concerns, raised crossings have been the preferred treatment over flashing beacons to enhance crossings at roundabouts, which present similar concerns to channelized right-turn lanes.

5.9 Traffic Signal Treatments

The stakeholders also participated in a discussion of signing and timing strategies employed at locations with CRTs controlled by a traffic signal. In general, the discussion centered around two primary items: right turn on red prohibitions and accessible pedestrian signals (including push buttons and audible signals). Commentary from participants related to traffic signal treatments is summarized below.

5.9.1 Right Turn on Red Prohibitions

- The Washington DOT noted a City of Seattle policy to employ No Turn on Red as a default, where engineers must develop a justification to request an exception to this policy.

- MnDOT has employed dynamic/blankout No Turn on Red signs at locations with dual channelized right turns as a means to increase driver compliance.

5.9.2 Accessible Pedestrian Signals

- APS devices are generally installed with any new pedestrian signal installations. These devices still provide important vibratory, tactile, and audible feedback for pedestrians, regardless of whether push buttons are utilized to activate the pedestrian signal.
- Several participants noted the importance of proper and consistent positioning of APS devices, which can represent a challenge at CRTs, particularly within small islands where space is limited. Pedestrian pushbuttons must be accessible for both wheelchair users and pedestrians with visual impairments.
- MnDOT noted that including all of the necessary signal equipment at CRTs, including appropriate APS devices, has posed challenges with snow removal due to the number of poles being located adjacent to the intersection.
- Orientation and mobility specialists noted that there has been exploratory research to determine the most effective use of audible countdowns as there may be potential drawbacks when devices are located close together or if the countdown message makes it more difficult for pedestrians with vision impairments to hear yielding vehicles.

5.10 Geometric Design Strategies

The final set of treatments that were discussed during the focus group sessions were those related to the geometric design of the channelized right-turn lanes or islands, including the use of deceleration or acceleration lanes, ramp designs (cut-through versus ramped), angle of entry at the CRT (high angle/conventional versus low angle/modern), and lane narrowing strategies. Feedback received from participants related to the various geometric designs is summarized in the subsections below.

5.10.1 Deceleration and Acceleration Lanes

The majority of participants indicated strong support for the use of deceleration lanes leading into the channelized right-turn lane, which allows for pedestrians, particularly those with vision impairments, to more effectively detect right-turning drivers. Participants also discouraged the use of acceleration lanes at CRTs with pedestrian activity. Acceleration lanes were noted to encourage higher speeds and less deceleration along the channelized right-turn lane, which can impact strategies used by visually impaired pedestrians to identify safe gaps.

5.10.2 Modern Low Angle of Entry Designs

While CRTs have historically been designed with angles of entry that are much higher than the usual 90 degrees, modern designs have reduced this entry angle to something closer to 90 degrees. Providing the low angle of entry provides several safety improvements, including a better head and eye positioning for right-turning drivers thereby improving the ability for drivers to detect pedestrians and lower speeds

within the channelized right-turn lane. Participants generally expressed a preference for the modern low angle of entry design over the conventional high angle of entry design. The Massachusetts DOT, Washington DOT, and Montgomery County each noted that their agencies utilized modern low angle of entry designs for CRTs, including modifying existing conventional CRTs to achieve a lower angle of entry.

5.10.3 Lane Narrowing and Radius Reductions

Strategies such as lane narrowing and radius reductions have been utilized at CRTs, often as retrofits at existing locations, in an attempt to lower speeds at CRTs. While agencies commonly modify the curblines as a part of retrofits to reduce corner radii or narrow lanes at CRTs, bollards or cross-hatched pavement markings are often utilized, including by MnDOT as a part of temporary demonstration projects. Participants provided the following feedback related to the types of strategies utilized to convey the radius reduction or lane narrowing:

- Participants agreed that curblines modifications were the most pedestrian-friendly method for providing lane narrowing or radius reductions, as such methods position the pedestrian landing area closer to the traffic lane, thereby improving pedestrian visibility to oncoming drivers and decreasing crossing distances.
- There was also general consensus that the use of pavement markings for lane narrowing or radius reductions, while less expensive, elicit less effective speed reductions compared to curb extensions, bollards, or other physical barriers used to delineate the vehicle path. These methods are also less desirable than curblines modifications, as the pedestrian landing area would remain at the original curblines, presenting wayfinding challenges for visually impaired pedestrians.
- Bollards are generally viewed as an improvement over pavement markings alone, but are regularly struck by vehicles which limits their effectiveness.
- There was a general preference towards placement of radius reductions on the right side of the lane to achieve the maximum speed reduction effect on drivers.

5.10.4 Truck Aprons

Truck aprons are often integrated along with radius reductions to better accommodate the turning requirement of large trucks, while still affording the intended speed reductions. Several participants indicated that the use of truck aprons presents challenges with respect to pedestrian ramp and crosswalk design, which can present wayfinding and orientation challenges for pedestrians with vision disabilities, particularly when determining where to safely stand while waiting to cross. Participants noted that detectable warning devices should be placed such that pedestrians with vision disabilities are able to identify the atypical crossing location. The use of tactile walking surface indicators may be needed to help further address these wayfinding concerns. The Washington DOT provided examples of truck aprons that have been designed to incorporate appropriate ADA features (**Figures 35-37**).



Figure 35. Peace Portal Drive and Hughes Avenue in Blaine, Washington [3].



Figure 36. Washington Route 520 and NE 51st Street in Redmond, Washington [3].



Figure 37. NE 171st Street and 135th Avenue in Woodinville, Washington [3].

5.10.5 Ramped vs. Cut-Through Channelizing Island Designs

Considerable discussion centered around the use of ramp versus cut-through designs as a means of providing pedestrian access through the channelized island. Opinions were somewhat split between the two designs. Participants who expressed a preference for the cut-through style, including the

Massachusetts DOT and Montgomery County, suggested the following benefits associated with cut-through pedestrian pathways:

- improved wayfinding for visually impaired pedestrians,
- improved refuge provided by the curblines while on the channelized island, and
- avoids ADA grade-challenges associated with ramped designs.

On the other hand, supporters of the ramped designs, including the Washington DOT and MnDOT, noted the following challenges associated with cut-through pedestrian pathways at the channelized islands leading them to favor the ramped designs:

- challenges with providing sufficient cut-through widths to accommodate the maneuverability requirements of wheelchair users, which is particularly problematic at small islands, and
- issues related to removing snow from within the cut through pathways in the island.

Chapter 6: Conclusions and Recommendations

This research, *Pedestrian Safety and Accessibility Best Practices for Channelized Right-Turn Lanes* (NS-694), sought to identify best practices for right-turn channelization that better accommodate the safety and accessibility needs for all road users. This was accomplished through a comprehensive literature review, a state-of-the-practice survey of state and local roadway agencies (nationwide and within Minnesota), a review of agency policy and guidance materials (nationwide and MnDOT), and a series of focus group meetings focused on vulnerable road users. The findings obtained from these tasks, which are presented in detail in **Chapters 2 - 5**, were synthesized to develop a series of conclusions and recommendations related to the design and implementation of CRTs within Minnesota to mitigate potential safety and accessibility concerns for vulnerable road users, particularly persons with vision impairments or other disabilities.

6.1 Benefits and Drawbacks of CRTs

It is first important to recognize that the limited number of CRT installations and variability in the designs of these installations create challenges in terms of performing meaningful and statistically valid safety performance analyses, which is where nearly all quantifiable benefits (or disbenefits) would be derived if such a relationship were observed. Consider that while several prior studies have evaluated the safety performance of CRTs and related design elements [15-21], the actual effects of CRTs on crashes and injuries remain largely unclear, particularly with respect to collisions involving pedestrians and bicyclists. Given the range of traffic control and geometric characteristics associated with CRTs, quantifying the effects of these designs on pedestrian and bicycle crashes and injuries was beyond the scope of this research. Thus, the benefits and drawbacks to CRTs presented herein are largely qualitative in nature.

Channelized right-turn lanes have historically been implemented, both in Minnesota and across the United States, to provide improved operations for vehicular traffic by allowing for the right-turn movement to be made at higher speeds without stopping, while also better accommodating turning maneuvers for trucks and other large vehicles. In addition, if properly designed, CRTs may offer potential benefits for some vulnerable road users, including:

- CRTs provide pedestrian refuge, which may improve comfort and safety
- CRTs reduce “multiple threat” risk for pedestrians crossing a multi-lane crosswalk who may otherwise be occluded by vehicles in an adjacent lane
- CRTs reduce “right-hook” collision risk, which is a common problem for bicyclists at intersections without CRTs due to vehicles turning right from the adjacent lane
- CRTs may improve visibility of the waiting pedestrian by positioning the pedestrian in a more favorable sight line for approaching drivers
- Similar to a roundabout, right-turning drivers at a CRT interact with the pedestrian prior to cross-street traffic, thereby allowing drivers to focus attention on the pedestrian

However, it is important to consider that CRTs present potential concerns for pedestrians, particularly those with vision impairments or other disabilities. In light of these concerns, it was noted by several focus group participants that disabled pedestrians, especially those with vision impairments, will typically avoid crossing intersections with CRTs whenever possible, particularly if the crosswalk is unsignalized. The specific concerns for pedestrians, including those with disabilities, include:

- CRTs are challenging for pedestrians to safely negotiate if the CRT is designed to accommodate high-speed free-flowing right-turn maneuvers, particularly in the absence of a traffic signal or traffic calming features at the crosswalk within the CRT.
- Despite the refuge provided by the channelizing island, the use of CRTs often results in longer overall crossing distances and out-of-direction travel for pedestrians, which create wayfinding challenges for disabled pedestrians.
- Participants of the focus group sessions performed as a part of this research noted that visually disabled pedestrians face the following wayfinding challenges at CRTs:
 - Identifying the appropriate location to cross
 - Properly orienting to the other side of the crosswalk
 - Properly re-orienting to the appropriate crosswalk landing area while within the channelized island
- Orientation specialists noted during the focus group sessions that CRTs are often not included in orientation training for visually impaired pedestrians, and common techniques used by visually impaired pedestrians to cross at conventional intersections may not be effective at CRTs.
- CRTs also present challenges for wheelchair users wishing to cross, due to the difficulties orienting toward the crosswalk and negotiating tight turns within channelized islands. These accessibility issues are exacerbated by accumulation of snow and ice at the crosswalk landing areas and within the channelized islands, particularly for cases where the sidewalks are cut into the island.

The integration of CRTs with bicycle facilities also presents potential challenges for bicyclists, which include:

- Conflicts at the point of entry to the channelized turn lane, which may potentially negate the reduced “right-hook” collision risk afforded by the CRT
- Bicyclists being overtaken within the channelized turn lane
- Wayfinding and connectivity for bicyclists traveling on off-road facilities, particularly in scenarios where shared-use paths or adjacent trails cross the CRT

6.2 Recommendations for CRT Design and Implementation

Feedback received both from the nationwide survey of transportation agencies and the focus group sessions performed as a part of this research suggest that roadway agencies throughout the United States are moving toward proactive policies for the use of CRTs that emphasize safety and mobility for vulnerable road users. This movement is generally based on the concerns for the safety of vulnerable road users outlined in the prior section and commonly includes: 1.) minimizing the use of CRTs at urban and suburban intersections and/or 2.) designing new CRT facilities or retrofitting existing facilities with

mitigation strategies to improve the safety and accessibility for vulnerable road users. This information was synthesized along with the best practices found in the research literature and agency policy/guidance materials to develop implementation guidance for use by transportation agencies in Minnesota, which is organized as follows. Specific guidance for use of CRTs based on the project scenario is provided in **Section 6.2.1**, including new construction projects, reconstruction projects, or safety projects involving existing CRTs. This guidance is followed by traffic control recommendations for CRTs (**Section 6.2.2**), recommended design features for CRTs (**Section 6.2.3**), and recommended mitigation strategies to improve CRT safety and/or accessibility for vulnerable road users (**Section 6.2.4**).

It is first important to note that the recommendations are tailored for consideration by MnDOT and local agencies in Minnesota consistent with state and federal law, weather, and existing practice. For example, Minnesota is a state which experiences between 36 to 70 inches of snowfall per year, depending on the geographic region [57]. This requires winter maintenance to be considered as a part of any roadway design and planning process – including CRTs where snow removal can impact the feasibility of potential mitigation strategies. In addition, Minnesota state law requires that drivers “stop to yield” to pedestrians who are “crossing the roadway within a marked crosswalk or at an intersection with no marked crosswalk” [58]. This is critically important for the selection of appropriate traffic control devices for CRTs in Minnesota. The recommendations also consider the revised *Public Right of Way Accessibility Guidelines* (PROWAG) requirements [48]; specifically, the impact to traffic control for multilane channelized right-turn lanes. Findings from the review of current practice in Minnesota were also considered as a part of the recommendation development process. It should also be noted that the recommendations are in conceptual agreement with *Section 8C.9.7.6 Channelized Right Turns* in MnDOT’s *Facility Design Guide* [59].

6.2.1 Recommended CRT Use by Project Scenario

The application of best practices regarding the use of CRTs in urban and suburban environments provides alignment with the Toward Zero Deaths and Vision Zero policies within Minnesota, along with the Minnesota Strategic Highway Safety Plan (SHSP), which seeks to better incorporate transit, pedestrians, and bicyclists in intersection design by providing facilities that limit potential conflicts with vehicles [5]. Meeting those ends will ultimately involve modifying the procedures for determining appropriate locations to implement new CRTs, while also proactively seeking to systemically retrofit existing CRTs with effective crash mitigation strategies. To ensure a proactive approach toward implementation of these strategies, a history of traffic crashes or conflicts involving pedestrians and bicyclists should not be required to obtain safety funding to enhance or remove CRTs. Particular emphasis should be placed on assessment and subsequent retrofitting of existing CRTs located along school routes or other pedestrian-focused corridors as these facilities can represent a barrier for vulnerable road users.

CRTs should be viewed as one of many tools for designers to consider as a part of managing the road network in a manner that maximizes safety and mobility for all road users. This inherently involves a balance between the operational and safety benefits potentially provided by CRTs versus the concerns related to non-motorized road users, which are outlined in **Section 6.1**. MnDOT and local roadway

agencies should therefore work toward developing consistent policies related to the use of CRTs for new and existing installations, which are detailed in this section, along with traffic control configurations (**Section 6.2.2**), design features (**Section 6.2.3**), and mitigation strategies (**Section 6.2.4**) that emphasize safety and accessibility for all road users. To support funding for implementation of safety enhancements involving CRTs, such projects should be integrated within the Minnesota Highway Safety Improvement Program (HSIP) and equivalent local agency safety program. **Table 19** provides recommended guidance for the use of CRTs in urban and suburban environments based on the project scenario, including new construction projects, reconstruction projects, or safety projects involving existing CRTs.

Table 19. Recommended CRT Use by Project Scenario

Scenario	Recommendation
New Construction Projects	<p>CRTs should not be used indiscriminately particularly in urban or suburban areas where pedestrians and bicyclists are expected to be present, and should be used only with careful consideration of overall benefits and disadvantages as it relates to that specific location. CRTs may be a viable alternative in scenarios where skew or other site-specific conditions could result in excessively long or awkward crossing geometry with the use of conventional non-channelized right-turn lanes (consistent with MnDOT Facility Design Guide [54]). There may also be other site-specific scenarios where design alternatives that include a CRT provide the best combination of safety and operational performance. Additionally, there may be scenarios where channelization offers signal phasing advantages.</p> <p>If CRTs are considered as a part of a new construction project, they should incorporate appropriate traffic control (Section 6.2.2), design features (Section 6.2.3) and mitigation strategies (Section 6.2.4) to maximize safety, mobility, and comfort for bicyclists and pedestrians, particularly those with disabilities.</p>
Reconstruction Projects	<p>When the boundaries of a reconstruction project in an urban or suburban area incorporates signalized intersections with existing CRTs, consideration may be given towards removal of the channelized right-turn lane when such removal may improve conditions for pedestrians and bicyclists.</p> <p>In scenarios where the removal of the CRT is not a feasible alternative, a review of the traffic control configuration (Section 6.2.2) should be conducted, and the reconstructed facility should incorporate consistent design features (Section 6.2.3) that emphasize pedestrians and bicyclists. Site-specific mitigation strategies (Section 6.2.4) should also be considered in order to maximize safety, mobility, and accessibility of the crossing.</p>
Safety Projects Involving Existing Channelized Right-Turn Lanes	<p>Both MnDOT and local roadway agencies should proactively seek to improve existing CRTs at signalized intersections in urban or suburban areas where pedestrians and bicyclists are expected to be present. This may include converting an existing channelized right-turn lane to a conventional right-turn lane or retrofitting these facilities with mitigation treatments intended to improve conditions for pedestrians and/or bicyclists (Sections 6.2.2 – 6.2.4). Such projects should be proactively considered on a systemic basis regardless of the occurrence of traffic crashes or conflicts involving pedestrians or bicyclists, although such data, if available, may also be utilized for support. Particular emphasis should be placed on existing CRTs along school routes or other pedestrian-focused corridors as these facilities can represent a barrier. To support funding for implementation of such projects, this component should be integrated within the</p>

Scenario	Recommendation
	Minnesota Highway Safety Improvement Program (HSIP) and equivalent local agency safety program along with other eligible funding programs.

6.2.2 Recommended Traffic Control for CRTs

The specific type of traffic control used on the CRT represents the component that most directly impacts safety for pedestrians and bicyclists at CRTs. MnDOT and local roadway agencies should work to develop policies and procedures to emphasize the consistent selection of traffic control for CRTs and incorporate similar configurations for each selected type of traffic control. **Table 20** provides recommendations toward the use/non-use of each of the four common types of traffic control employed at CRTs for the state of Minnesota. Note that the recommendations in **Table 20** do not necessarily relate to the traffic control at the crosswalk within the CRT, except where noted within the table. Please consult **Section 6.2.3** and **Section 6.2.4** for additional enhancements aimed at improving pedestrian and bicyclist safety while crossing the CRT.

Table 20. Recommended Traffic Control for CRTs

Traffic Control	Recommendation
Uncontrolled	The use of uncontrolled CRTs should be minimized in urban and suburban areas where non-motorized road users are expected to cross. Either removing or altering the traffic control at existing locations where these “free-right-turn” designs are employed represents an opportunity to advance the state’s safety goals by improving conditions for pedestrians and bicyclists.
Yield Control	Yield control represents the most common approach for single lane channelized right-turn facilities at signalized intersections in Minnesota. While there is a general perception among roadway agencies and vulnerable road users that traffic signal control provides the safest and most comfortable crossing experience, yield control can represent an acceptable configuration with appropriate design features (Section 6.2.3) and site-specific mitigation strategies (Section 6.2.4). The R1-2 sign yield is typically placed at the downstream end of the channel in Minnesota, as shown in Figure 2A-3 of the Minnesota MUTCD [55]. It should be noted that the yield sign must not be placed at the crosswalk itself, as Minnesota state law requires that drivers “stop to yield” to pedestrians who are “crossing the roadway within a marked crosswalk or at an intersection with no marked crosswalk”. While not commonly used in Minnesota, advance yield pavement markings may also be included consistent with the Minnesota MUTCD [55]. It should be noted that the revised PROWAG requirements for multilane facilities [48] require a RRFB, PHB, or raised crossing if the CRT is not signalized.
Stop Control	While stop control may offer benefits to pedestrians and bicyclists at specific locations by enforcing a regulatory complete stop within the channel, this type of CRT control also negates many of the operational benefits afforded by the reduction in unnecessary stops at CRTs and may also be disregarded by drivers at locations with low pedestrian crossing activity. Nevertheless, stop control may represent a low-cost option to improve the crossing environment for pedestrians at locations where right-turning volumes are relatively low and moderate pedestrian volumes. However, confusion may be caused by the intent of the stop signs at CRTs as these signs are intended to control the vehicular conflict and are not intended to control the crosswalk upstream of the intersecting street.

Traffic Control	Recommendation
Signal Control	<p>Given the general perception among roadway agencies and other safety stakeholders that traffic signal control provides the safest and most comfortable crossing experience for pedestrians at CRTs, signal control is widely understood to be the traffic control alternative preferred by pedestrians. This is particularly true for pedestrians with disabilities, who desire signal control to be provided at the crosswalk itself and be of an accessible design. While signal control does not address many of the wayfinding concerns experienced by visually disabled pedestrians at CRTs, the protected crossing movement provided by the red indication represents an advantage over yield control for these users. Furthermore, the use of signal control at the crosswalk within a CRT satisfies the revised PROWAG requirements for multilane channelized facilities [48]. At most locations, vehicular signalization on the CRT would be used at both the CRT crosswalk and the cross street merge point, while some locations may include signalization only at the CRT crosswalk. It is also important to consider that given the short distance of the CRT crossing, it is likely that many pedestrians will opt to cross without activating the pedestrian phase, and in doing so, would be crossing in violation of a solid “Don’t Walk” signal indication and thus without the right-of-way normally afforded to crosswalk users. One option to remedy this is to allow the vehicular signal at the CRT crosswalk to dwell in a flashing yellow arrow or ball (rather than green), along with dark pedestrian indications, except when activated by a pedestrian. Doing so allows pedestrians to retain the right-of-way within the crosswalk without activation of the pedestrian phase.</p> <p>Signal phasing and timing for the overall intersection should place special emphasis on accommodating the pedestrian crossing movements. It is general practice to phase the pedestrian crossing at the CRT lane to run opposite of the phases for the conflicting right-turning traffic at the CRT, including through-traffic phases and any overlapped right-turn phases (e.g., right turns paired with protected left-turns on the cross street). It is worth noting that with a default phasing strategy, if all four quadrants of an intersection include a channelized right-turn lane, all directional pedestrian crossings would require two pedestrian phases to complete, which often increases the total pedestrian crossing time compared to crossings at traditional intersections without CRTs. Modern signal controllers often allow for pedestrian phases to be overlapped, which would allow for a pedestrian phase across the CRT lane to be paired with the directional left-turn movements, during which the conflicting right-turning traffic at the CRT would be stopped. Overlapped pedestrian phases provide the potential for more efficient pedestrian signal timing and reduced crossing times.</p> <p>The specifics of the traffic signal design (such as the selection or arrangement of signal heads) should be consistent with common practice at other non-channelized intersections. Common options for signal indications for CRT lanes include: 5-section heads with three circular indications and two arrow indications, 3-section heads with arrows only, 3-section heads with circular indications only, 4-section heads with arrows only (with flashing yellow arrows), and others. The choice of the signal head arrangement and signal indications is dependent on how the signal is phased. The placement of required accessible pedestrian signals (APS) at CRTs, which include tactile and audible features, requires careful consideration due to the atypical geometry of the CRT designs.</p> <p>If signalization is used for traffic control for the CRT movement, care should be taken to use signal timing strategies to help avoid vehicle-to-vehicle conflicts at the point where traffic from</p>

Traffic Control	Recommendation
	the CRT merges with downstream traffic from the main intersection. Potential strategies include longer clearance times for traffic approaching the merge conflict point from the main intersection or delaying the start of the CRT movement.

6.2.3 Recommended CRT Design Features

There are a number of design features that influence safety and accessibility for non-motorized road users at CRTs beyond the selected traffic control configuration. **Table 21** provides a summary of recommendations specific to these features that represent fundamental design decisions that must generally be considered for all CRTs in urbanized areas.

Table 21. Recommended CRT Design Features

Design Feature	Recommendation
Crosswalk Markings and Placement	<p>The decision to include crosswalk pavement markings and the selection of the type of crosswalk markings (if used) represents a fundamental design consideration at CRTs. Given the challenging crossing environment presented by CRTs, the inclusion of high-visibility crosswalk markings, such as longitudinal bars, ladder, or bar pair markings, provides for a relatively low-cost enhancement to provide guidance to pedestrians with low vision and to remind drivers of the crossing location.</p> <p>All new or reconstructed CRT designs where pedestrians are expected to cross should include high-visibility crosswalk markings as a standard. While high-visibility crosswalk markings should also be incorporated as a component of safety projects to enhance existing locations, this should not be viewed as a standalone safety treatment. Guidance in the MnDOT <i>Traffic Engineering Manual</i> [56] to generally not install crosswalk markings at CRTs should be revised. While it is acknowledged that maintaining these pavement markings represents an increased cost for both MnDOT and local roadway agencies, the crossing environment should represent a focus of CRTs where pedestrians and bicyclists are expected to be present.</p>

Design Feature	Recommendation
----------------	----------------

It is important to recognize that the optimal crosswalk placement requires the consideration of site-specific geometric conditions and the flexibility provided within the Minnesota MUTCD [55]. However, the center-perpendicular placement, depicted in Option 3 in the following image, should be viewed as the default approach for CRTs (particularly for locations with yield control) and subsequently adjusted to fit site conditions. For example, downstream placements may be more appropriate for locations with signals that are positioned at the crossroad.

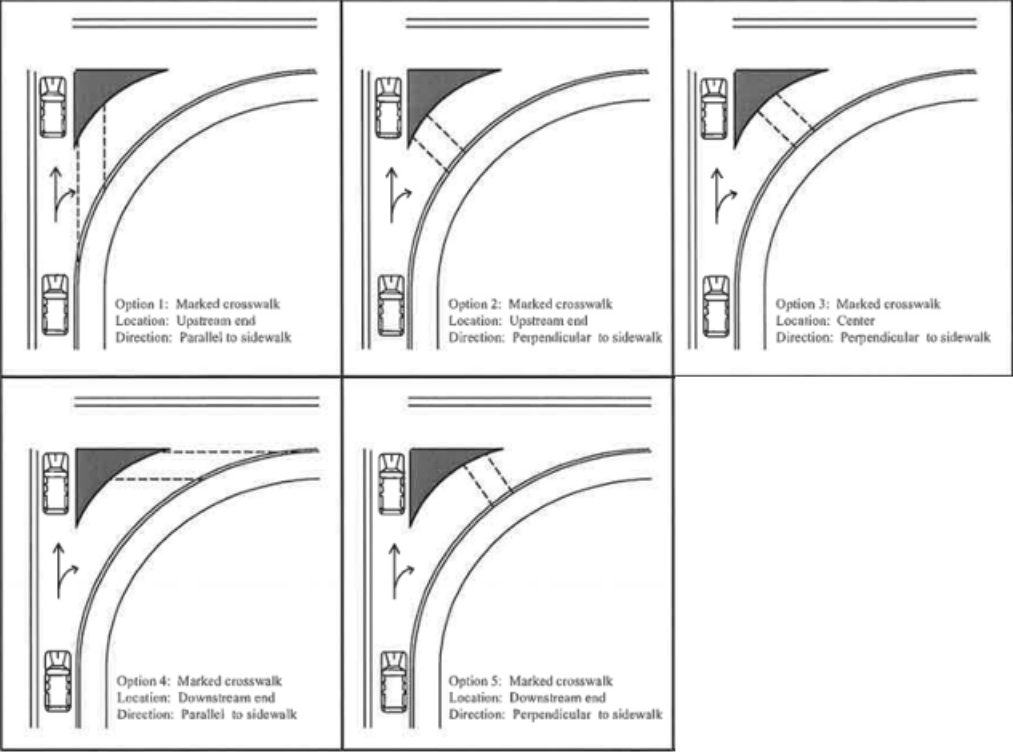

Examples of Crosswalk Placement Strategies within CRTs [1]

Angle of Entry

Consistent with MnDOT’s *Bicycle Facility Design Manual* [53] and the *Facility Design Guide* [54], the modern low angle of entry design should be the standard approach for CRTs in Minnesota. All new and reconstructed channelized facilities should work towards the geometric design demonstrated below within the constraints of site-specific conditions. Additionally, both MnDOT and local agencies should proactively seek to retrofit existing CRTs with the modern low angle of entry approach as a systemic safety project. While there have been instances of drivers encroaching beyond the end of the channel into the cross street, local agencies noted that edgeline extensions have been used to address this concern.

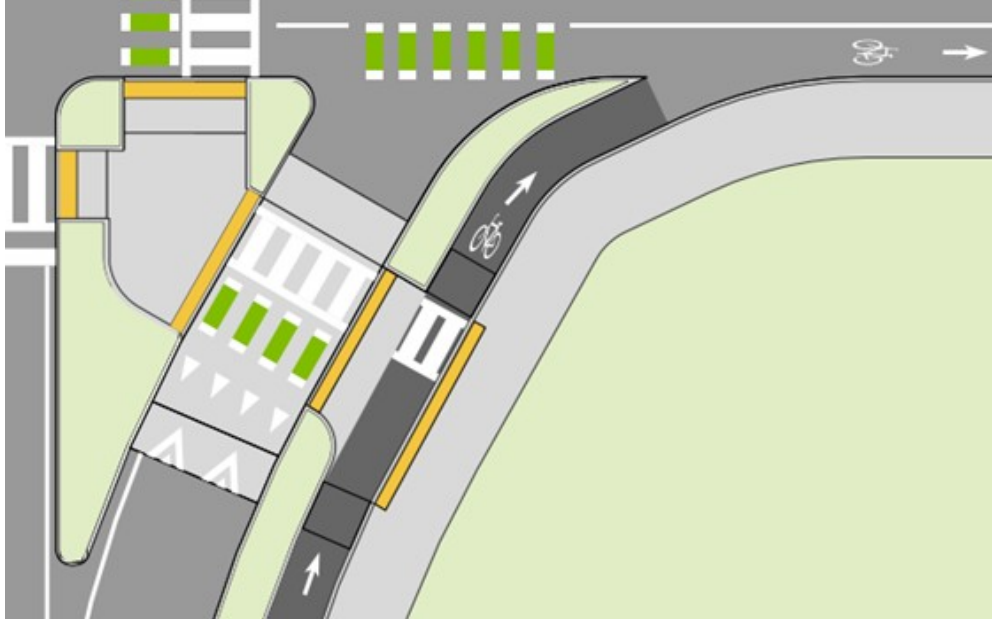
Design Feature	Recommendation
	 <p data-bbox="581 852 1252 884">Example of Modern Low Angle of Entry CRT Design [33]</p>
Channelizing Island Design	<p data-bbox="418 890 1421 1062">The design of CRTs should consider how the size of channelizing islands and the related crossing paths influence safety and accessibility for non-motorized road users. Refer to the AASHTO Green Book [2] and Schroeder et al. [25] for detailed guidance with regard to island design, including appropriate size, crossing path through the island, and other geometric design principles.</p> <p data-bbox="418 1087 1421 1293">With respect to island size, the MnDOT <i>Bicycle Facility Design Manual</i> [53] suggests that channelizing islands should be large enough to store either bicycles with trailers or groups of bicyclists – including space that is at least six feet long but ideally at least ten feet long. The use of larger islands can help to ensure space for the required traffic control devices, pedestrian pathing, and bicycle storage. In general, at least 100 square feet is recommended in urban areas.</p> <p data-bbox="418 1318 1421 1671">It is critical to provide appropriate guidance through the channelizing island for pedestrians with vision disabilities and ensure that the area outside of the crossing path be identifiable as a non-walking surface, as islands without this guidance can be disorienting [25]. Both the cut through (i.e., level with the street) or ramped approaches to accommodating crossing paths through channelizing islands are acceptable options depending on the goals of the designer and site-specific conditions. However, the complications associated with snow removal have resulted in the ramped approach representing the preferred alternative in Minnesota. Given the importance of emphasizing consistency in CRT design, MnDOT and local agencies should work towards standardizing the preferred approach.</p>

Design Feature	Recommendation
Deceleration and Acceleration Lanes	<p>Deceleration lanes have generally been identified as positive for pedestrians and represent a commonly included design element at CRTs. All new and reconstructed designs should generally incorporate deceleration lanes. The use of CRTs should be minimized in design scenarios where the inclusion of a deceleration lane is infeasible due to site-specific conditions. Both MnDOT and local agencies should proactively seek to remove or retrofit existing CRTs without deceleration lanes where non-motorized road users are expected to be present.</p> <p>The use of acceleration lanes should be avoided due to the fact these designs are intended to increase operating speeds and reduce the driver expectation of yielding. Consistent with the AASHTO <i>Green Book</i> [2], the use of acceleration lanes should be generally limited to facilities where pedestrians are not expected to cross. This scenario would commonly include “free-right-turn” designs employed in rural areas. Acceleration lanes should not be included with new or reconstructed designs. Both MnDOT and local agencies should proactively seek to remove or retrofit existing CRTs with acceleration lanes where non-motorized road users are expected to be present.</p>

6.2.4 Mitigation Strategies for CRTs



Beyond the new PROWAG requirements for multilane facilities [48], there are a number of potential mitigation strategies that should be considered to enhance crossings when CRTs are used in contexts where pedestrians and bicyclists are expected to be present. These mitigation strategies should be employed on a case-by-case basis depending on site-specific conditions and the selected traffic control configuration (**Section 6.2.2**). These strategies, either used individually or in combination, may be appropriate for new construction projects, reconstruction projects, or safety projects to improve existing CRTs. Guidance is provided in **Table 22** for the recommended use of these strategies for CRTs in Minnesota.

Table 22. Mitigation Strategies for CRTs

Strategy	Recommended Use
<p>Raised Crosswalks</p>	<p>The use of raised crossings at CRTs represents a potential enhancement option to consider that has been used successfully by state and local roadway agencies in a number of traffic control configurations. Raised crossings are also one of the treatments identified within the revised PROWAG requirements for multilane channelized facilities [48]. Raised crossings have previously been implemented in Minnesota in other roadway settings and are also identified in the <i>Minneapolis Street Design Guide</i> [34]. The <i>MnDOT Bicycle Facility Design Manual</i> [53] recommends the use of a raised crossing to improve the visibility of pedestrians and bicyclists. However, it must be noted that raised crossings are currently not allowed on state-aid routes in Minnesota.</p> <p>While roadway agencies have identified difficulties related to winter maintenance or buses bottoming out after passing over the facility due to the total height of the raised crossing, the grade break and ramp design can help to ensure the treatment is effective, even in cases where the total height of the raised crossing is relatively low. It is also critical to ensure that these designs consider how pedestrians with disabilities will interact with the crossing. For example, designs without any slope before the crosswalk or misaligned detectable warning devices can lead to potential confusion.</p>
<p>W11-2 Pedestrian Crossing Warning Signs</p>	<p>MUTCD W11-2 signs are one of the fundamental traffic control devices that can be used to supplement crossings at CRTs across several traffic control configurations. It should be noted that these devices should be used on a case-by-case basis as there may be site-specific situations where visual clutter represents a potential concern. In other words, W11-2 signs do not represent a standard treatment that should be included as a component of all CRTs in urbanized areas where pedestrians are expected to cross. Instead, these signs should be considered as one potential option to enhance the crossing in conjunction with other mitigation strategies</p>
<p>R1-5 Yield/Stop Here for Pedestrian Signs</p>	<p>Historically roadway agencies have used R1-5 signs to enhance crossings at CRTs with a variety of design configurations. However, the 11th edition of the MUTCD limits the use of R1-5s to multilane applications [28]. The R1-5b/c “stop” variant of the signs therefore represents a potential option to consider at dual channelized right-turn lanes.</p>



Strategy	Recommended Use
<p>R10-15 <i>Turning Vehicles Yield/Stop Here for Pedestrian Signs</i></p>	<p>R10-15 signs are another regulatory sign that can be used to emphasize crossings at CRTs with a variety of design configurations. These signs may offer an alternative to R1-5s for single lane channelized facilities given the multilane restriction included in the 11th edition of the MUTCD [28].</p> 
<p>Pedestrian-Actuated Beacons or Warning Devices</p>	<p>Both rectangular rapid-flashing beacons (RRFBs) and pedestrian hybrid beacons (PHBs) can be used to enhance crossings at CRTs with yield control. It should be noted that both devices are included within the revised PROWAG requirements [48] as treatments to satisfy accessibility requirements for multilane facilities. Ultimately, the use of RRFBs or PHBs are site-specific treatments that should be considered as an alternative to signal control of the channelized lane.</p>
<p>Right Turn on Red Restrictions</p>	<p>Both static and dynamic Right Turn on Red (RTOR) restrictions can be considered to improve safety and accessibility for pedestrians at signalized CRTs where RTOR is otherwise allowed. It should be noted that recent research sponsored by the department has suggested that overall compliance rates are higher at locations with static No Turn on Red Treatments in a general setting [60].</p>
<p>Lane Narrowing, Radius Reductions, and Truck Aprons</p>	<p>Lane narrowing and radius reductions can also be used to address concerns at CRTs related to corner radii or excessively wide pavement cross-sections that allow for relatively high turning speeds. Treatments range from the use of bollards or cross-hatched pavement markings to a permanent modification of the curb line. While curbline modifications are the most desirable design alternative from a pedestrian perspective, bollards or pavement markings can also represent an improvement over existing conditions in certain circumstances. Bollards or cross-hatched pavement markings could also be used as a part of short-term demonstration projects. Radius reductions should generally be implemented on the right side of the channelized lane to achieve the maximum speed reduction effect on drivers.</p> <p>Mountable truck aprons may also be integrated along with radius reductions to better accommodate the turning requirement of large trucks, while still affording the intended speed reductions. However, it is critical to ensure that pedestrian ramp and crosswalk design accommodate the potential wayfinding and orientation challenges for pedestrians with vision disabilities.</p>

Strategy	Recommended Use
	 <p data-bbox="505 688 1341 722">Example of Lane Narrowing/Radius Reduction (with Truck Apron) [3]</p>
Tactile Warning Surface Indicators	<p data-bbox="427 745 1421 884">Tactile walking surface indicators, such as those depicted in the image below, are an emerging option to assist visually impaired pedestrians with wayfinding and orientation at crosswalks where typical cues used by visually impaired pedestrians (such as adjacent road noise or detectable edges) can be misleading.</p>  <p data-bbox="505 1392 1341 1425">Example of Tactical Walking Surface Indicators at a Roundabout [61]</p>
Bicycle Lane Connections to Sidepaths	<p data-bbox="427 1438 1421 1682">One innovative approach is to connect bicycle lanes with sidepaths upstream of the CRT to allow bicyclists who feel uncomfortable traveling within the roadway at these locations to move to facilities outside of the traveled way. However, it was noted during focus groups that such designs create potential conflicts between bicyclists entering from the roadway and pedestrians, which is of a particular concern for visually disabled pedestrians who may be struggling with wayfinding at the channelized right-turn lane.</p>

References

1. Potts, I.B., D.W. Harwood, D. Torbic, S.A. Hennum, C.B. Tiesler, J.D. Zegeer, ... & J.M. Barlow. (2006). *Synthesis on Channelized Right Turns at Intersections on Urban and Suburban Arterials*. Washington, DC: Transportation Research Board.
2. American Association of State Highway and Transportation Officials, (2018). *A Policy on Geometric Design of Highways and Streets*, 7th Edition. Washington, DC: American Association of State Highway and Transportation Officials.
3. Google, LLC. (n.d.). Google Maps. Retrieved from <https://www.google.com/maps>
4. Minnesota Department of Transportation. (2022). Traffic Engineering – Crash data. Retrieved from <https://www.dot.state.mn.us/trafficeng/safety/crashdata.html>
5. Minnesota Department of Transportation. (2020). *2020-2024 Strategic Highway Safety Plan*. Retrieved from <http://www.dot.state.mn.us/trafficeng/safety/shsp/>
6. Minnesota Department of Transportation. (2021). *Statewide Pedestrian System Plan*. Retrieved from <https://www.dot.state.mn.us/minnesotawalks/index.html>
7. United States Department of Transportation. (n.d.). What Is a Safe System Approach? Retrieved from <https://www.transportation.gov/NRSS/SafeSystem>
8. Muley, D., M. Kharbeche, W. Alhajyaseen, & M. Al-Salem (2017). Pedestrians' Crossing Behavior at Marked Crosswalks on Channelized Right-Turn Lanes at Intersections. *Procedia Computer Science*, 109, 233-240.
9. van Hapern, W., S. Daniels, T. de Ceunynck, N. Saunier, & G. Wets (2018). Yielding Behavior and Traffic Conflicts at Crossing Facilities at Channelized Right-Turn Lanes. *Transportation Research Part F: Traffic Psychology and Behaviour*, 55, 272-281.
10. Jiang, C., R. Qiu, T. Fu, L. Fu, B. Xiong, & Z. Lu (2020). Impact of Right-Turn Channelization on Pedestrian Safety at Signalized Intersections. *Accidental Analysis and Prevention*, 136, 105399.
11. Macfarlane, G., M. Saito, & G. Schultz (2011). *Driver Perceptions at Free Right-Turn Channelized Intersections*. Chicago, IL: First Congress of Transportation and Development Institute.
12. Al-Kaisey, A., S. Roefaro, & D. Veneziano (2012). Effectiveness of Signal Control at Channelized Right-Turning Lanes: An Empirical Study. *Journal of Transportation Safety & Security*, 4, 19-34.
13. Schroeder, B., N. Rooupail, & R. Wall Emmerson (2006). Exploratory Analysis of Crossing Difficulties for Blind and Sighted Pedestrians at Channelized Turn Lanes. *Transportation Research Record*, 1956, 94-102.
14. Schroeder, B., R. Hughes, N. Roupail, C. Cunningham, K. Salamati, R. Long, ... & E. Myers (2011). *National Cooperative Highway Research Program Report 674: Crossing Solutions at Roundabouts and Channelized Turn Lanes for Pedestrians with Vision Disabilities*. Washington, DC: Transportation Research Board.
15. Potts, I., D. Harwood, K. Bauer, D. Gilmore, J. Hutton, D. Torbic, ... & J. Barlow (2014). *Design Guidance for Channelized Right-Turn Lanes*. Washington, DC: Transportation Research Board.
16. Dixon, K., J. L. Hibbard, & H. Nyman (1999). Right-Turn Treatment for Signalized Intersections. *Transportation Research Circular*, E-C019. Dallas, TX: Urban Street Symposium.

17. Fitzpatrick, K., W. Schneider, & E.S. Park (2006). Operation and Safety of Right-Turn Lane Designs. *Journal of the Transportation Research Board*, 1961, 55-64.
18. Schattler, K., T. Hanson, & K. Maillacheruvu (2016). Effectiveness Evaluation of a Modified Right-Turn Lane Design at Intersections. Urbana, IL: Illinois Center for Transportation.
19. Bara, U. (2018). Safety Effect of Smart Right-turn Design at Intersections. *Institute of Transportation Engineers Journal*, 88, 38-43.
20. Sacchi, E., T. Sayed, & P. deLeur (2013). A Comparison of Collision-Based and Conflict-Based Safety Evaluations: The Case of Right-Turn Smart Channels. *Accident Analysis and Prevention*, 59, 260-266.
21. Ukkusuri, S., L. Ling, T. Le, & W. Zhang (2020). *Performance of Right-Turn Lane Designs at Intersections*. Indianapolis, IN: Indiana Department of Transportation.
22. American Association of State Highway and Transportation. (2021). *AASHTO Guide for the Planning, Design, and Operation of Pedestrian Facilities*, 2nd Edition. Washington, D.C.: American Association of State Highway and Transportation.
23. American Association of State Highway and Transportation Officials, (2012). *Guide for the Development of Bicycle Facilities*, 4th Edition. Washington, D.C.: American Association of State Highway and Transportation.
24. Neuman, T. R. (1985). *Intersection Channelization Guide* (NCHRP Report 279). Washington, DC: Transportation Research Board.
25. Schroeder, B., L. Rodegerdts, P. Jenior, E. Myers, C. Cunningham, K. Salamati, ... & B. L. Bentzen. (2017). *Crossing Solutions at Roundabouts and Channelized Turn Lanes for Pedestrians with Vision Disabilities: A Guidebook* (National Cooperative Highway Research Program Research Report 834). Washington, DC: Transportation Research Board.
26. Schroeder, B., L. Rodegerdts, P. Jenior, E. Myers, C. Cunningham, K. Salamati, ... & B.L. Bentzen. (2016). *National Cooperative Highway Research Program Web-Only Document 222: Guidelines for the Application of Crossing Solutions at Roundabouts and Channelized Turn Lanes for Pedestrians with Vision Disabilities*. Washington, DC: Transportation Research Board.
27. Tarawneh, M. S. & P. T. McCoy (1996). Effect of Intersection Channelization and Skew on Driver Performance. *Journal of the Transportation Research Board*, 1523, 73-82.
28. Federal Highway Administration. (2023). *Manual on Uniform Traffic Control Devices*. Washington, DC: Federal Highway Administration.
29. Al-Kaisy, A. & S. Roefaro .(2012). Channelized Right-Turn Lanes at Signalized Intersections: The U.S. Experience. *Advances in Transportation Studies: An International Journal*, B 26, 57-68.
30. Federal Highway Administration. (2021). *Crosswalk Visibility Enhancements* (FHWA-SA-21-049). Washington, DC: Federal Highway Administration.
31. Alston, M., B. Schroeder, S. Brown., S. W. O'Brien, T. Saleem, K. Brookshire, & P. Ryus. (2023). Factors Affecting Driver Yielding at Uncontrolled Crosswalks. *Transportation Research Record*, 2677, 212-223.
32. Zeeger, C., R. Srivivasan, B. Lan, D. Carter, S. Smith, C. Sundstrom, ... & R. Van Houten (2017). *Development of Crash Modification Factors for Uncontrolled Pedestrian Crossing Treatments* (NCHRP Research Report 841). Washington, DC: Transportation Research Board.
33. Blackburn, L., M. Dunn, R. Martinson, P. Robie, & K. O'Reilly (2022). *Improving Intersections for Pedestrians and Bicyclists: Informational Guide*. Washington, DC: Federal Highway Administration.

34. City of Minneapolis. (n.d.). *Street Design Guide*. Retrieved from <https://sdg.minneapolismn.gov/>
35. Staplin, K., K. Lococo, S. Byington, & D. Harkey (2001). *Highway Design Handbook for Older Drivers and Pedestrians*. Washington, DC: Federal Highway Administration.
36. Federal Highway Administration. (n.d.). *Pedestrian Safety Guide and Countermeasure Selection System*. Retrieved from <http://www.pedbikesafe.org/pedsafe/index.cfm>
37. Federal Highway Administration. STEP Studio. Washington, DC: Federal Highway Administration.
38. Baumanis, C. & R. Machemehl (2022). *Driver Compliance with Pedestrian Crossings at Non-Signalized Intersections*. Charlotte, NC. Center for Advanced Multimodal Mobility Solutions and Education.
39. Van Houten, R., H. Hochmuth, & D. Dixon (2018). An Examination of the Effects of the Gateway R1-6 Treatment on Drivers' Yielding Right-of-Way to Pedestrians, Speed at Crosswalk, and Sign Durability Over Time. Paper presented at the 97th Annual Meeting of the Transportation Research Board, 1/7/2018 to 1/11/2018, Washington, DC:
40. Stapleton, S., T. Kirsch, T. Gates, & P. Savolainen (2017). Factors Affecting Driver Yielding Compliance at Uncontrolled Midblock Crosswalks on Low-Speed Roadways. *Transportation Research Record*, 2661, 95-102.
41. Van Houten, R. & J. Hochmuth (2016). *Comparison of Alternative Pedestrian Crossing Treatments*. Lansing, MI: Michigan Department of Transportation.
42. Fitzpatrick, K., S. Turner, M. Brewer, P. Carlson, B. Ullman, N. Trout, ... & D. Lord (2006). *Improving Pedestrian Safety at Unsignalized Intersections (NCHRP Report 562)*. Washington, DC: Transportation Research Board.
43. Federal Highway Administration. (2018). Pedestrian Hybrid Beacon (PHB) Countermeasure Tech Sheet (FHWA-SA-18-064). Washington, DC: Federal Highway Administration.
44. Fitzpatrick, K. & E. S. Park (2010). *Safety Effectiveness of the HAWK Pedestrian Crossing Treatment*. College Station, TX: Texas Transportation Institute.
45. Van Houten, R., J. LAPlante, & T. Gustafson (2012). *Evaluating Pedestrian Safety Improvements*. Lansing, MI: Michigan Department of Transportation.
46. Shurbutt, J. & R. Van Houten (2010). *Effects of Yellow Rectangular Rapid-Flashing Beacons on yielding at Multilane Uncontrolled Crosswalks*. Washington, DC: Federal Highway Administration.
47. Fitzpatrick, K., R. Avelar, I. Potts, M. Brewer, J. Robertson, C. Fees, ... & K. Bauer (2015). *Investigating Improvements to Pedestrian Crossings with an Emphasis on the Rectangular Rapid-Flashing Beacon*. Washington, DC: Federal Highway Administration.
48. U.S. Access Board. (2023). *Public Right-of-Way Accessibility Guidelines*. Washington, DC : Architectural and Transportation Barriers Compliance Board .
49. Federal Highway Administration. (2021). *Leading Pedestrian Interval (FHWA-SA-21-032)*. Washington, DC: Federal Highway Administration.
50. Federal Highway Administration. (2016). *Achieving Multimodal Networks*. Washington, DC: Federal Highway Administration.
51. Gemar, M., Z. Wafa, J. Duthie, & C. Bhat. (2015). *A Report on the Development of Guidelines for Applying Right-Turn Slip Lanes*. Austin, TX: Texas Department of Transportation.
52. Federal Highway Administration. (2024). State Bicycle and Pedestrian Coordinator. Retrieved from https://www.fhwa.dot.gov/environment/bicycle_pedestrian/state_contacts.cfm

53. Minnesota Department of Transportation. (2024). *Bicycle Facility Design Manual*. Retrieved from <https://www.dot.state.mn.us/bike/bicycle-facility-design-manual.html>
54. Minnesota Department of Transportation. (2024). *Facility Design Guide*. St. Paul, MN: MnDOT. Retrieved from <https://roaddesign.dot.state.mn.us/facilitydesign.aspx>
55. Minnesota Department of Transportation. (2023). *Minnesota Manual on Uniform Traffic Control Devices*. St. Paul, MN: MnDOT.
56. Minnesota Department of Transportation. (2015). *Traffic Engineering Manual*. St. Paul, MN: MnDOT.
57. Minnesota Department of Natural Resources. (n.d.). Climate, Frequently Asked Questions. Retrieved from <https://www.dnr.state.mn.us/climate/faqs.html#:~:text=The%20average%20annual%20snowfall%20in%20Minnesota%20varies%20from%2036%20inches,the%20total%20precipitation%20received%20annually>
58. State of Minnesota. (2023). 2023 Statutes, 169.21 PEDESTRIAN. Retrieved from <https://www.revisor.mn.gov/statutes/cite/169.21>
59. Minnesota Department of Transportation. (2024). *Facility Design Guide*, Section 8C.9.7.6 Channelized Right Turns. Retrieved from <https://roaddesign.dot.state.mn.us/facilitydesign.aspx>
60. Day, C. M, A. Sharma, M. S. Arya, Y. Zhang, P. Sapkota, & N. Oneyar. (2024). *Evaluation of Static and Dynamic No Right Turn on Red Signs at Traffic Signals*. St. Paul, MN: MnDOT.
61. Accessible Design for the Blind. (2024). *Blind Pedestrian Crossing at Roundabout Without and With TDI*. Retrieved from <https://www.youtube.com/watch?v=IGVq6jWnAFg&t=1s>
62. Federal Highway Administration. (n.d.) Raised Crosswalk Countermeasure Tech Sheet. Retrieved from https://highways.dot.gov/sites/fhwa.dot.gov/files/2022-06/techSheet_RaisedCW2018.pdf

Appendix A: Roadway Agency Survey Questionnaire Form

Roadway Agency Survey Questionnaire Form



Greetings!

This survey is being distributed on behalf of the Minnesota Department of Transportation and seeks to identify practices, policies, and guidelines related to improving pedestrian and bicyclist safety at signalized intersections with **channelized right turn lanes**.

SURVEY OVERVIEW:

The initial series of questions relate to traffic control and design strategies utilized for channelized right turn lanes within your jurisdiction, including:

- Types of traffic control
- Crosswalk surface treatments
- Crosswalk placement
- Crosswalk signs and beacons
- Traffic signals
- Geometric design
- Strategies for pedestrians with vision impairments or other disabilities

The survey concludes with requests for policy or guidance materials from your agency, examples of innovative treatments, and any other potential contacts who may have helpful information.

INSTRUCTIONS:

Please respond to each question as you are comfortable and able, and feel free to forward this along to others within your agency if you believe that someone else would be better suited to respond. Your responses are automatically saved upon proceeding to the next page. If you need to exit prior to completion, you may return to the survey by clicking on the link sent found in the email invitation.

Please contact Tim Gates (gatestim@msu.edu) with any questions or concerns.

Name

Your Position or Title

Agency

Email Address

Phone Number

Initially, participants were asked to describe their agency's use of channelized right-turn lanes:



Roadway Agency Use of Channelized Right Turn Lanes

Does your agency utilize channelized right turn lanes at signalized intersections where pedestrians and bicyclists are expected to cross?

- Yes
- No
- Unsure

If “No” was selected, the participant was provided one final question:



Does your agency’s decision to not use channelized right turn lanes at signalized intersections involve safety concerns specific to pedestrians and bicyclists?

- Yes
- No
- Unsure

Please provide any other detail related to your agency’s decision to not use channelized right turn lanes in these scenarios.

If “Unsure” was selected, the participant was provided one final question:



Other Contacts for Channelized Right Turn Lane Treatments

Please provide contact information for anyone else within your agency who may provide useful information pertaining to methods for improving safety at channelized right turn lanes.

Are you aware of any local agencies (i.e., cities, townships, counties, or MPOs) within your state or other out-of-state agencies that employ innovative practices for improving safety at channelized right turn lanes that you would recommend we contact? If so, please provide their contact information below.

Otherwise, the participant was provided with a series of questions:

Traffic Control Types for Channelized Right Turn Lanes

Please indicate the frequency of use of the following **types of traffic control** at channelized right turn lanes in your jurisdiction. Only consider locations where the main intersection is signalized and pedestrians or bicyclists are expected to cross the channelized right turn lane.

Click on any hyperlinked treatment for an example image, which will open in new window.

	Never	Rarely	Sometimes	Frequently	Unsure
No Control	<input type="radio"/>	<input type="radio"/>	<input type="radio"/>	<input type="radio"/>	<input type="radio"/>
Yield Control	<input type="radio"/>	<input type="radio"/>	<input type="radio"/>	<input type="radio"/>	<input type="radio"/>
Stop Control	<input type="radio"/>	<input type="radio"/>	<input type="radio"/>	<input type="radio"/>	<input type="radio"/>
Signal Control	<input type="radio"/>	<input type="radio"/>	<input type="radio"/>	<input type="radio"/>	<input type="radio"/>

Crosswalk Surface Treatments at Channelized Right Turn Lanes

Please indicate the frequency of use of the following types of **crosswalk surface treatments** at channelized right turn lanes in your jurisdiction. Only consider locations where the main intersection is signalized and pedestrians or bicyclists are expected to cross the channelized right turn lane.

Click on any hyperlinked treatment for an example image, which will open in new window.

	Never	Rarely	Sometimes	Frequently	Unsure
High-Visibility Crosswalk Markings	<input type="radio"/>	<input type="radio"/>	<input type="radio"/>	<input type="radio"/>	<input type="radio"/>
Raised Crosswalks	<input type="radio"/>	<input type="radio"/>	<input type="radio"/>	<input type="radio"/>	<input type="radio"/>
Advance Yield Markings	<input type="radio"/>	<input type="radio"/>	<input type="radio"/>	<input type="radio"/>	<input type="radio"/>
Texturing Crosswalks	<input type="radio"/>	<input type="radio"/>	<input type="radio"/>	<input type="radio"/>	<input type="radio"/>
Other <input type="text"/>	<input type="radio"/>	<input type="radio"/>	<input type="radio"/>	<input type="radio"/>	<input type="radio"/>
Other <input type="text"/>	<input type="radio"/>	<input type="radio"/>	<input type="radio"/>	<input type="radio"/>	<input type="radio"/>

Please provide any comments related to your agency's experience with crosswalk surface treatments at channelized right turn lanes.



Crosswalk Placement at Channelized Right Turn Lanes

Please indicate the frequency of use of the following types of **crosswalk placement strategies** at channelized right turn lanes in your jurisdiction. Only consider locations where the main intersection is signalized and pedestrians or bicyclists are expected to cross the channelized right turn lane.

Click on any hyperlinked treatment for an example image, which will open in new window.

	Never	Rarely	Sometimes	Frequently	Unsure
Upstream End of Channelized Lane Parallel to Sidewalk	<input type="radio"/>	<input type="radio"/>	<input type="radio"/>	<input type="radio"/>	<input type="radio"/>
Upstream End of Channelized Lane Perpendicular to Sidewalk	<input type="radio"/>	<input type="radio"/>	<input type="radio"/>	<input type="radio"/>	<input type="radio"/>
Center of Channelized Lane Perpendicular to Sidewalk	<input type="radio"/>	<input type="radio"/>	<input type="radio"/>	<input type="radio"/>	<input type="radio"/>
Downstream End of Channelized Lane Parallel to Sidewalk	<input type="radio"/>	<input type="radio"/>	<input type="radio"/>	<input type="radio"/>	<input type="radio"/>
Downstream End of Channelized Lane Perpendicular to Sidewalk	<input type="radio"/>	<input type="radio"/>	<input type="radio"/>	<input type="radio"/>	<input type="radio"/>
Other <input type="text"/>	<input type="radio"/>	<input type="radio"/>	<input type="radio"/>	<input type="radio"/>	<input type="radio"/>
Other <input type="text"/>	<input type="radio"/>	<input type="radio"/>	<input type="radio"/>	<input type="radio"/>	<input type="radio"/>

Please provide any comments related to your agency's experience with crosswalk placement at channelized right turn lanes.

Crosswalk Signs and Beacons at Channelized Right Turn Lanes

Please indicate the frequency of use of the following types of **crosswalk signs or beacons** at channelized right turn lanes in your jurisdiction. Only consider locations where the main intersection is signalized and pedestrians or bicyclists are expected to cross the channelized right turn lane.

Click on any hyperlinked treatment for an example image, which will open in new window.

	Never	Rarely	Sometimes	Frequently	Unsure
R1-5 Signs	<input type="radio"/>	<input type="radio"/>	<input type="radio"/>	<input type="radio"/>	<input type="radio"/>
In-Street R1-6 Signs	<input type="radio"/>	<input type="radio"/>	<input type="radio"/>	<input type="radio"/>	<input type="radio"/>
Curbside R1-6 Signs	<input type="radio"/>	<input type="radio"/>	<input type="radio"/>	<input type="radio"/>	<input type="radio"/>
W11-2 Signs	<input type="radio"/>	<input type="radio"/>	<input type="radio"/>	<input type="radio"/>	<input type="radio"/>
Overhead Amber Beacons	<input type="radio"/>	<input type="radio"/>	<input type="radio"/>	<input type="radio"/>	<input type="radio"/>
Sign-Mounted Amber Beacons	<input type="radio"/>	<input type="radio"/>	<input type="radio"/>	<input type="radio"/>	<input type="radio"/>
Rectangular Rapid-Flashing Beacons (RRFB)	<input type="radio"/>	<input type="radio"/>	<input type="radio"/>	<input type="radio"/>	<input type="radio"/>
Pedestrian Hybrid Beacons (PHB)	<input type="radio"/>	<input type="radio"/>	<input type="radio"/>	<input type="radio"/>	<input type="radio"/>
Other <input type="text"/>	<input type="radio"/>	<input type="radio"/>	<input type="radio"/>	<input type="radio"/>	<input type="radio"/>
Other <input type="text"/>	<input type="radio"/>	<input type="radio"/>	<input type="radio"/>	<input type="radio"/>	<input type="radio"/>

Please provide any comments related to your agency's experience with crosswalk signs or beacons at channelized right turn lanes.

Traffic Signal Strategies for Crosswalks at Channelized Right Turn Lanes

Please indicate the frequency of use of the following types of **traffic signal strategies for crosswalks** at channelized right turn lanes in your jurisdiction. Only consider locations where the main intersection is signalized and pedestrians or bicyclists are expected to cross the channelized right turn lane.

Click on any hyperlinked treatment for an example image, which will open in new window.

	Never	Rarely	Sometimes	Frequently	Unsure
Pedestrian Push-Buttons (implemented strictly due to the use of Channelized Right Turn Lane)	<input type="radio"/>	<input type="radio"/>	<input type="radio"/>	<input type="radio"/>	<input type="radio"/>
Accessible Pedestrian Signals	<input type="radio"/>	<input type="radio"/>	<input type="radio"/>	<input type="radio"/>	<input type="radio"/>
Leading Pedestrian Intervals (at the Channelized Right Turn Lane)	<input type="radio"/>	<input type="radio"/>	<input type="radio"/>	<input type="radio"/>	<input type="radio"/>
Static RTOR Restrictions	<input type="radio"/>	<input type="radio"/>	<input type="radio"/>	<input type="radio"/>	<input type="radio"/>
Dynamic RTOR Restrictions	<input type="radio"/>	<input type="radio"/>	<input type="radio"/>	<input type="radio"/>	<input type="radio"/>
Green Ball Signal Indications	<input type="radio"/>	<input type="radio"/>	<input type="radio"/>	<input type="radio"/>	<input type="radio"/>
Green Arrow Signal Indications	<input type="radio"/>	<input type="radio"/>	<input type="radio"/>	<input type="radio"/>	<input type="radio"/>
Flashing Yellow Arrow Signal Indications	<input type="radio"/>	<input type="radio"/>	<input type="radio"/>	<input type="radio"/>	<input type="radio"/>
Roadside Mounted Signals	<input type="radio"/>	<input type="radio"/>	<input type="radio"/>	<input type="radio"/>	<input type="radio"/>
Overhead Signals	<input type="radio"/>	<input type="radio"/>	<input type="radio"/>	<input type="radio"/>	<input type="radio"/>
Overhead and Roadside Signals Together	<input type="radio"/>	<input type="radio"/>	<input type="radio"/>	<input type="radio"/>	<input type="radio"/>
Other <input type="text"/>	<input type="radio"/>	<input type="radio"/>	<input type="radio"/>	<input type="radio"/>	<input type="radio"/>
Other <input type="text"/>	<input type="radio"/>	<input type="radio"/>	<input type="radio"/>	<input type="radio"/>	<input type="radio"/>

Please provide any comments related to your agency's experience with traffic signal strategies for crosswalks at channelized right turn lanes.



Geometric Design and Other Treatments for Channelized Right Turn Lanes

Please indicate the frequency of use of the following types of **geometric design strategies or other treatments** at channelized right turn lanes in your jurisdiction. Only consider locations where the main intersection is signalized and pedestrians or bicyclists are expected to cross the channelized right turn lane.

Click on any hyperlinked treatment for an example image, which will open in new window.

	Never	Rarely	Sometimes	Frequently	Unsure
Deceleration Lane	<input type="radio"/>	<input type="radio"/>	<input type="radio"/>	<input type="radio"/>	<input type="radio"/>
Acceleration Lane	<input type="radio"/>	<input type="radio"/>	<input type="radio"/>	<input type="radio"/>	<input type="radio"/>
Cut Through Crossing Path at Island	<input type="radio"/>	<input type="radio"/>	<input type="radio"/>	<input type="radio"/>	<input type="radio"/>
Ramped Crossing Path at Island	<input type="radio"/>	<input type="radio"/>	<input type="radio"/>	<input type="radio"/>	<input type="radio"/>
Low Angle of Entry	<input type="radio"/>	<input type="radio"/>	<input type="radio"/>	<input type="radio"/>	<input type="radio"/>
High Angle of Entry	<input type="radio"/>	<input type="radio"/>	<input type="radio"/>	<input type="radio"/>	<input type="radio"/>
Lane Narrowing (using Pavement Markings or Curb Extensions)	<input type="radio"/>	<input type="radio"/>	<input type="radio"/>	<input type="radio"/>	<input type="radio"/>
Other <input type="text"/>	<input type="radio"/>	<input type="radio"/>	<input type="radio"/>	<input type="radio"/>	<input type="radio"/>
Other <input type="text"/>	<input type="radio"/>	<input type="radio"/>	<input type="radio"/>	<input type="radio"/>	<input type="radio"/>

Please provide any comments related to your agency's experience with geometric design strategies or other treatments at channelized right turn lanes.

Accommodating Pedestrians and Bicyclists at Channelized Right Turns

Please provide any other comment on your agency's experience with strategies for accommodating pedestrians or bicyclists at channelized right turn lanes. In particular, please consider any special accommodations for persons with vision impairments or other disabilities.

Agency Policies or Guidance for Right Turn Channelization

If your agency maintains any policies or guidelines specific to the use of channelized right turn lanes, please provide a link below.

Alternatively, please upload any of these materials here.

Drop files or click here to upload



Examples of Innovative Channelized Right Turn Lane Treatments

Please provide the location of any innovative channelized right turn lane treatments that have been implemented within your jurisdiction. This could include simply the identification of the cross streets or coordinates to allow the research team to review the site.

Alternatively, please upload any of photographs of the location or other materials here.

Drop files or click here to upload



Other Contacts for Channelized Right Turn Lane Treatments

Please provide contact information for anyone else within your agency who may provide useful information pertaining to methods for improving safety at channelized right turn lanes.

Are you aware of any local agencies (i.e., cities, townships, counties, or MPOs) within your state or other out-of-state agencies that employ innovative practices for improving safety at channelized right turn lanes that you would recommend we contact? If so, please provide their contact information below.

Appendix B. Minnesota Local Agency Participants

Minnesota Local Agency Participants

Level of Participation	Name	Agency
Focus Group and Survey	Kirk Roberts	City of Bloomington
Focus Group and Survey	Andrew Witter	Sherburne County
Focus Group and Survey	Joe Gustafson	Washington County
Focus Group and Survey	John Hagen	City of Maple Grove
Focus Group and Survey	Tim Plath	City of Eagan
Focus Group and Survey	Sam Budzyna	City of Rochester
Focus Group and Survey	Joseph Wilson	Lincoln County
Focus Group	David Bennet	City of Northfield
Focus Group	Chris Hartzell	City of Woodbury
Focus Group	Bradley Estochen	Ramsey County
Focus Group	Vic Lund	St. Louis County
Focus Group	David Sheen	Hennepin County
Focus Group	Adam Gadbois	City of Eden Prairie
Survey	Dale Marty	Goodhue County
Survey	Bob Jopp	City of St. Cloud
Survey	Jeremy Gilb	Chippewa County
Survey	Bruce Hasbargen	Beltrami County
Survey	Emily Morrison	Carlton County
Survey	Jarret Hubbard	Rochester Olmsted Council of Governments (ROCOG)
Survey	James Kosluchar	City of Fridley

Appendix C. Vulnerable Road User Focus Group Participants

Vulnerable Road User Focus Group Participants

Focus Group	Name	Affiliation
#1 (5/31/2024)	Michael Samuelson	Multimodal Coordinator, Minnesota DOT Metro District
#1 (5/31/2024)	Mimi Stender	Duluth Aging Support
#1 (5/31/2024)	Peter Grund	Minneapolis Advisory Committee on People with Disabilities (MACOPD)
#2 (6/4/2024)	Lukas Franck	Orientation and Mobility Specialist (Vision Impairments), The Seeing Eye
#2 (6/4/2024)	Matt Johnson	Planner, Montgomery County, Maryland and bicycle advocate
#2 (6/4/2024)	Fransico Lovera	Complete Streets Engineer, Massachusetts DOT
#2 (6/4/2024)	Briana Weisgerber	Active Transportation Division, Washington DOT
#3 (6/6/2024)	Michael Sack	Minneapolis Advisory Committee on People with Disabilities (MACOPD) and wheelchair user
#3 (6/6/2024)	Kenneth Loen	Assistant State Design Engineer for Active Transportation, Washington DOT
#3 (6/6/2024)	Suzy Scotty	Senior Ped/Bike/ADA Planner, MnDOT Metro District
#4 (6/10/2024)	Steven Prusak	Active Transportation Engineer, State Aid for Local Transportation, Minnesota DOT
#4 (6/10/2024)	Haley Foydel	Hennepin County Active Transportation Committee (HCATC) and bicycle advocate
#4 (6/10/2024)	Beezy Bentzen	Orientation and Mobility Specialist (Vision Impairments), Accessible Design for the Blind
#4 (6/10/2024)	Zach Veaner	Accessibility Engineer, Massachusetts DOT
#4 (6/10/2024)	Deborah Hendrickson	Pedestrian and Bike Subcommittees of the Duluth Bicycle Pedestrian Advocacy Committee (BPAC)
Email Response	Alexa Huth	Member of Minneapolis Advisory Committee on People with Disabilities and visually impaired individual
Email Response	Guthrie Byard	Community Specialist for People with Disabilities, Neighborhood and Community Relations, City of Minneapolis
Email Response	Jennifer Graham	Orientation and Mobility Specialist (Vision Impairments), Accessible Design for the Blind